

On-Line UPS

PowerWalker VFI 1000 RT HID

PowerWalker VFI 1500 RT HID

PowerWalker VFI 2000 RT HID

PowerWalker VFI 3000 RT HID



Manual

EN

CONTENT

1. Safety and EMC Instructions	1
1.1 Installation	1
1.2 Operation	9
1.3 Maintenance, servicing and faults	10
1.4 Transport.....	13
1.5 Storage	13
1.6 Standards.....	14
2. Description of Commonly Used Symbols	15
3. Introduction	16
4. Panel Description	17
5. Connection and Operation	19
5.1 Inspection.....	19
5.2 Connection.....	19
5.3 Battery charge.....	21
5.4 Turn on the UPS	21
5.5 Test function	21
5.6 Turn off the UPS	22
5.7 Audible alarm mute function	22
5.8 Operation procedure of external battery for long backup time model (“S” model)	22
6. Operating Mode for All Models	24
6.1 Line mode	24
6.2 Battery mode.....	25
6.3 Bypass mode	25
6.4 NO output mode.....	26
6.5 EPO (Emergency Power Off).....	26
6.6 ECO mode (Economy mode).....	26
6.7 Converter mode	27
6.8 Abnormal mode.....	27
7. Setting by LCD Module	28
8. Trouble Shooting	30
9. Maintenance	33

9.1 Operation	33
9.2 Storage	33
9.3 Battery Replace	33
10. Technical Data.....	34
10.1 Electrical specifications.....	34
10.2 Operating Environment.....	34
10.3 Typical backup time (Typical values at 25°C in minutes:).....	34
10.4 Dimensions and weights.....	35
11. Communication Port.....	36
11.1 RS-232 and USB communication ports.....	36
11.2 RS-232 port.....	36
11.3 USB port	37
11.4 Installing a Serial Network Management Card (optional)	37
11.5 Dry Contact port.....	37
12. Software Installation.....	39
Appendix: Rear panel.....	40

1. Safety and EMC Instructions

SAVE THESE INSTRUCTIONS – This manual contains important instructions for models PowerWalker VFI 1000/1500/2000/3000RT HID that should be followed during installation and maintenance of the UPS and batteries.

Please read carefully the following user manual and the safety instructions before installing the unit or using the unit!

1.1 Installation

- This product is specially designed for PCs and it is not recommended for use in any life-supporting system and other specific important equipment.
- Do not connect household or other appliances or items of equipment which would overload the UPS (e.g. laser printers, hair dryers, etc) to the UPS output.
- This unit intended for installation in a controlled environment (temperature controlled, indoor area free of conductive contaminants).
- Condensation may occur if the UPS is moved directly from a cold to a warm environment. The UPS must be absolutely dry before being installed. Please allow an acclimatization time of at least two hours.
- Risk of electric shock, do not remove cover. No user serviceable parts inside. Refer servicing to qualified service personnel.
- The utility power outlet shall be near the equipment and easily accessible. To isolate UPS from AC input, remove the plug from the utility power outlet.
- If UPS is to be stored for a long time, it is recommended to recharge the batteries (by connecting the utility power to UPS, switch “ON”), once a month for 24 hours to avoid a full battery discharge.
- Please do not use the UPS in excess of the rated load capacity.
- The UPS contains large-capacity batteries. So the shell shall not be opened, otherwise such dangers as electric shock will be caused. If any internal overhaul or replacement of the battery is required, please contact the distributor.

- The internal short circuiting of the UPS will lead to dangers such as electric shock or fire, therefore, no water containers (such as a water glass) shall be placed on the top of the UPS so as to avoid such dangers as electric shock.
- Do not dispose of battery or batteries in a fire. The battery may explode.
- Do not open or mutilate the battery or batteries. Released electrolyte is harmful to the skin and eyes. It may be toxic.
- Icon Φ on the rating label stands for phase symbol.
- A battery can present a risk of electrical shock and high short circuit current. The following precautions should be observed when working on batteries :
 - Remove watches, rings, or other metal objects from the hand.
 - Use tools with insulated handles.
 - Servicing of batteries should be performed or supervised by personnel knowledgeable of batteries and the required precautions. Keep unauthorized personnel away from batteries.
 - When replacing batteries, replace with the same type and number of the sealed lead-acid batteries.
 - This pluggable type A equipment with battery already installed by the supplier is operator installable and may be operated by laymen.
 - During the installation of this equipment it should be assured that the sum of the leakage currents of the UPS and the connected loads does not exceed 3.5mA.
 - Attention, hazardous through electric shock. Also with disconnection of this unit from the mains, hazardous voltage still may be accessible through supply from battery. The battery supply should be therefore disconnected in the plus and minus pole of the battery when maintenance or service work inside the UPS is necessary.
 - The mains socket outlet that supplies the UPS shall be installed near the UPS and shall be easily accessible.
 - Place cables in such a way that no one can step on or trip over them.
 - Assure to connect the UPS and external battery pack with the earth reliably
 - Do not block ventilation openings in the UPS's housing. Ensure the air vents on the front and rear of the UPS are not blocked. Allow at

least 25cm of space on each side.

- In case smoke is found coming out from the device, please cut off the power supply quickly and contact the distributor.
- An appropriate disconnect device as short-circuit backup protection should be provided in the building wiring installation. Please see the disconnect device specification in chapter 5.2
- Do not keep or use this product in any of the following environments:
 - Any area with combustible gas, corrosive substance, heavy dust, standing water or running water.
 - Any area with extraordinarily high or low temperature (above 40°C or below 0°C) and humidity of more than 90%.
 - Any area exposed to direct sunshine or near any heating apparatus. (Maximum ambient temperature rating is 40°C.)
 - Any area with serious vibrations.
 - Outdoor.
- In the event that there is fire occurring in the vicinity, please use dry-power extinguishers. The use of liquid extinguishers may give rise to the danger of electric shock.

1.1.1 Inspection of Unit

Inspect the UPS upon receiving. If the UPS is apparently damaged during the shipment, please keep the box and packing material in original form for the carrier and notify the carrier and dealer immediately.

1.1.2 Unpacking the Cabinet

To unpack the system:

1. Open the outer carton and remove the accessories packaged with the cabinet.
2. Carefully lift the cabinet out of the outer carton and set it on a flat, stable surface.
3. Discard or recycle the packaging in a responsible manner, or store it for future use.

1.1.3 UPS Setup

All model series are designed for tower and rack purpose. They can be installed into a 19 inches equipment rack. Please follow the instruction for

Tower Setup and Rack-Mount Setup.

● Tower setup

This series of UPS can be placed horizontally and vertically. As a tower configuration, it is provided with the optional UPS stands to stabilize the UPS when the UPS is positioned in vertical. The UPS stand must be attached to the bottom of the tower. Use the following procedure to install UPS in UPS stands.

1. Slide down the UPS vertically and put two UPS stands at the end of the tower.
2. Place down the UPS into two stands carefully.
3. Pull out the LCD box and rotate it in a clockwise direction to 90 degree and then push it back in the front panel.

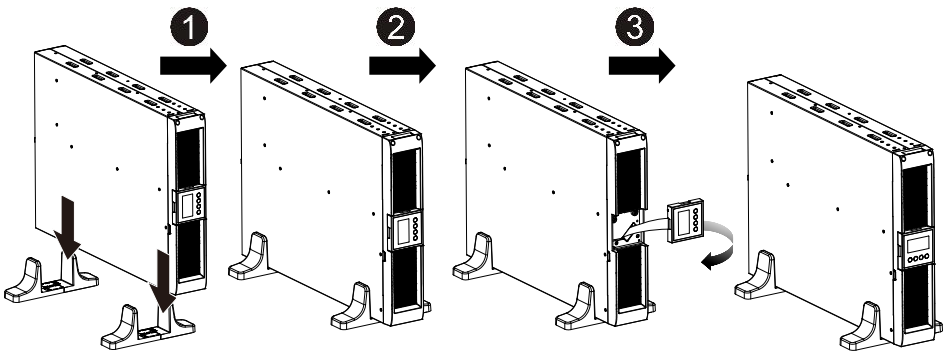

● Rack-mount setup

The series can be installed in 19 inches racks. Both the UPS and external battery enclosure need 2U of rack space.

Use the following procedure to install UPS in a rack.

1. Align the mounting ears with screw holes on the side of the UPS, and tighten the screw.
2. Assemble the rack rails with the rack-mounting.
3. Slide in the UPS into the rack rail and lock it in the Rack-mounting.
4. Tighten the screw, and then the load can be connected.

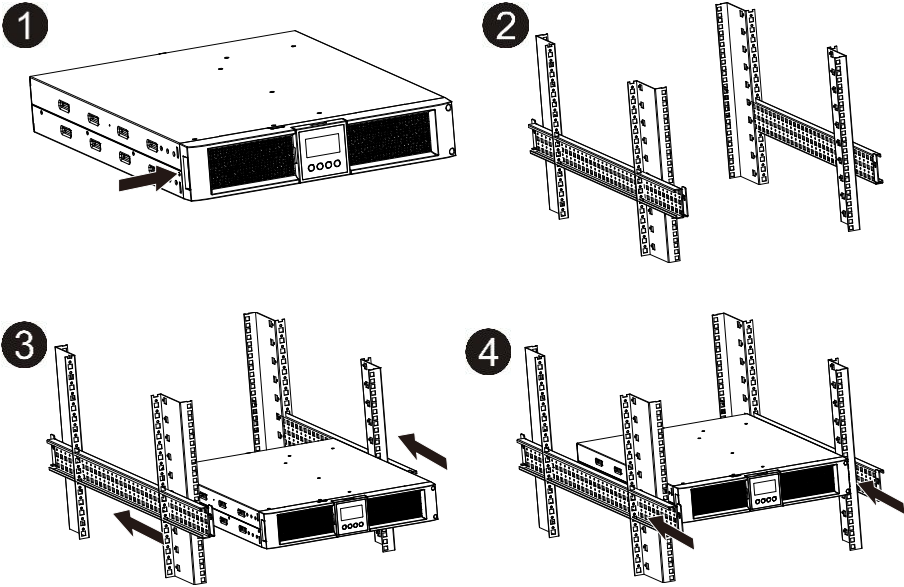

1.1.4 EBM Installation (Optional)

● Connecting the EBM in Tower form:

1. Slide down the UPS and EBM vertically and place two UPS stands with the extend part at the end of the tower.
2. Tighten the screw on the metal sheet for stabilization
3. Connect the Earth line from UPS (port A) to EBM (port B)
4. Take off the front panel, and connect the battery terminal (A) from UPS to EBM terminal (B) shown as below. Users need to remove the small gate(C) on side of the front panel to allow the outlet wire of the EBM to pass through the gate and then reassemble front panel.

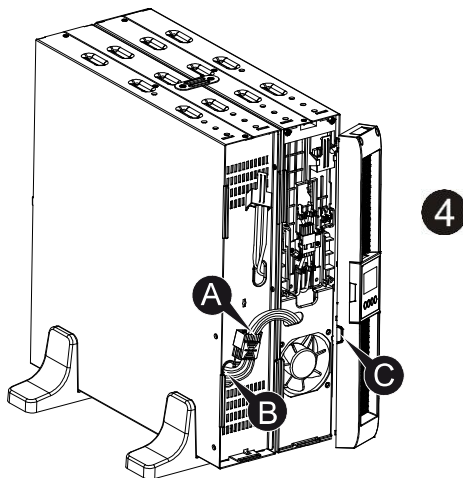
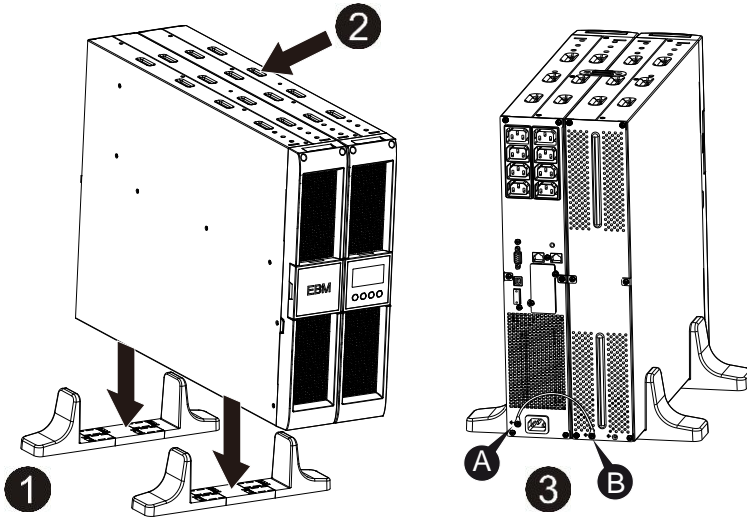

● Connecting the EBM in a rack form

1. Using the same method as assembling UPS in a rack form, assemble EBM into the rack-mounting on the top or bottom of the UPS.
2. Connect the earth line from UPS (port A) to EBM (port B)
3. Take off the LCD box, and unscrew the internal screws.
4. Take off the front panel, and connect the battery terminal (A) from UPS to EBM terminal (B) shown as below. Users need to remove the small gate(C) on side of the front panel to allow the outlet wire of the EBM to pass through the gate and then reassemble front panel.
5. After installing the UPS into rack, the load can then be connected to UPS. Please make sure the load equipment is turned off before plugging all loads into the output receptacle

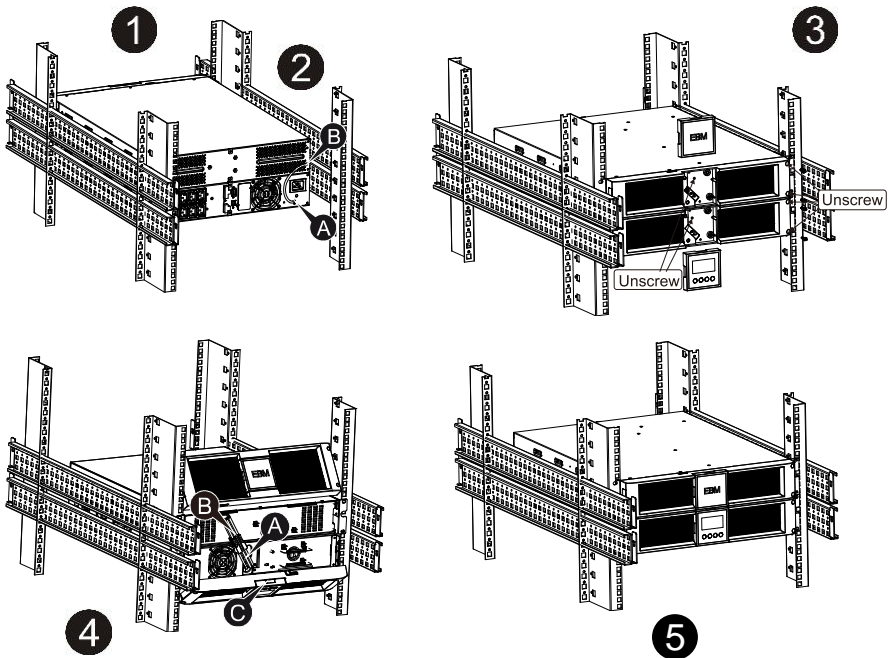

● Connecting the Multiple EBMs

1000VA/1500VA/2000VA and 3000VA UPS include external battery port that allows users to connect multiple EBM in order to provide additional backup

time. Follow the procedure to install multiple EBM as below.

● **Connecting multiple EBMs in Tower form**

1. Connect Earth line between UPS and the first EBM, and then connect Earth Line between the first EBM and the second EBM.
2. Take off the front panel, and connect the battery terminal (A) from UPS to EBM terminal (B) shown as below. And then connect the battery terminal (D) from the first EBM to the battery terminal (E) from the second EBM. Users need to remove the small gate(C) on side of the front panel to allow the outlet wire of the EBM to pass through the gate and then reassemble front panel.

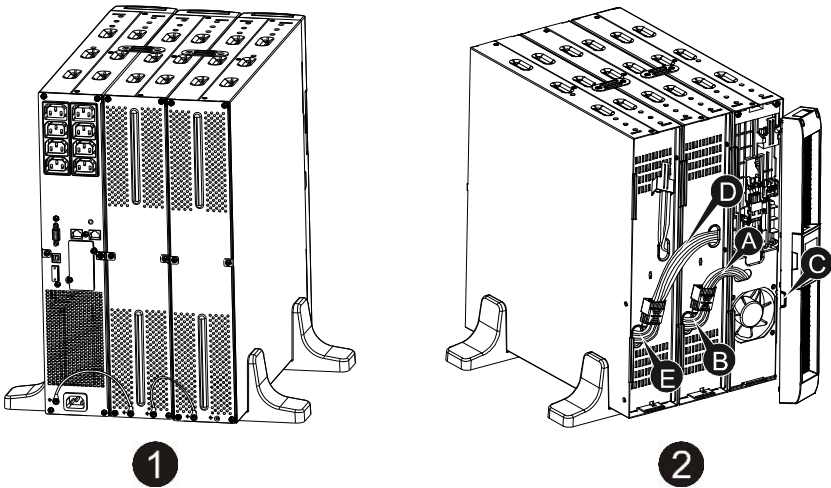

● **Connecting the Multiple EBMs in rack form**

1. Connect Earth line between UPS and the first EBM, and then connect Earth Line between the first EBM and the second EBM.
2. Take off the front panel, and connect the battery terminal (A) from UPS to EBM terminal (B) shown as below. And then connect the battery terminal (D) from the first EBM to the battery terminal (E) from the second EBM. Users need to remove the small gate(C) on side of the front panel to allow the outlet wire of the EBM to pass through the gate and then reassemble front panel.

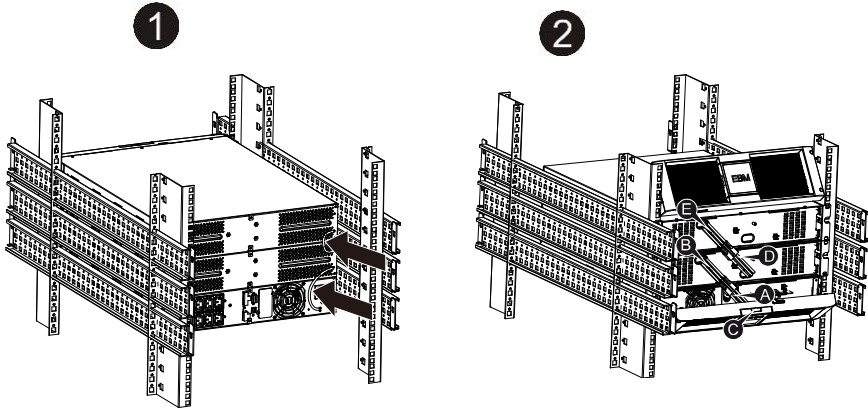

Note: Three or more EBMs can be connected to the UPS in the same way as shown above.

Note: After connect the EBMs, please do not forget to set the number of EBMs on LCD, please refer to chapter 7 “Setting by LCD module” for setting method. If use the nonstandard EBMs, please call local dealer or distributor for setting method.

1.2 Operation

- ★ Do not disconnect the mains cable on the UPS or the building wiring socket (grounded shockproof socket) during operation as this would remove the ground to the UPS and of all connected loads.
- ★ The UPS features its own, internal current source (batteries). You may be electric shock when you touch the UPS output sockets or output terminal block even if the UPS is not connected to the building wiring socket.
- ★ In order to fully disconnect the UPS, first press the OFF button to turn off the UPS, then disconnect the mains lead.
- ★ Ensure that no liquid or other foreign objects can enter the UPS.
- ★ Do not remove the enclosure. This system is to be serviced by qualified service personnel only.
- ★ Remove the protective panel only after disconnecting the terminal connections.

- ★ Use No. 12 AWG (for 3KS input wire), 90°C copper wire and 4.4 lb-in Torque force when connecting to terminal block.
- ★ Use No. 10AWG (for all models battery wire), 90°C copper wire and Anderson PP45 connectors for user's external battery cabinet.

1.3 Maintenance, servicing and faults

- ★ The UPS operates with hazardous voltages. Repairs may be carried out only by qualified maintenance personnel.
- ★ Caution - risk of electric shock. Even after the unit is disconnected from the mains power supply (building wiring socket), components inside the UPS are still connected to the battery which are potentially dangerous.
- ★ Before carrying out any kind of service and/or maintenance, disconnect the batteries. Verify that no current is present and no hazardous voltage exists in the capacitor or BUS capacitor terminals.
- ★ Batteries must be replaced only by qualified personnel.
- ★ Caution - risk of electric shock. The battery circuit is not isolated from the input voltage. Hazardous voltages may occur between the battery terminals and the ground. Verify that no voltage is present before servicing!
- ★ Batteries have a high short-circuit current and pose a risk of shock. Take all precautionary measures specified below and any other measures necessary when working with batteries:
 - remove all jewellery, wristwatches, rings and other metal objects
 - use only tools with insulated grips and handles.
- ★ When changing batteries, replace with the same quantity and the same type of batteries.
- ★ Do not attempt to dispose of batteries by burning them. It could cause explosion.
- ★ Do not open or destroy batteries. Effluent electrolyte can cause injury to the skin and eyes. It may be toxic.
- ★ Please replace the fuse only by a fuse of the same type and of the same amperage in order to avoid fire hazards.
- ★ Do not dismantle the UPS, except the qualified maintenance personnel.

1.3.1 UPS and Battery Care

For the best preventive maintenance, keep the area around the UPS clean and dust-free. If the atmosphere is very dusty, clean the outside of the system with a vacuum cleaner. For long battery life, keep the UPS at an ambient temperature of 25°C (77°F)

1.3.2 Storing the UPS and Batteries

When the UPS is intended to store for a long period, recharge the battery every 6 months by connecting the UPS to utility power. The batteries charge to 90% capacity in approximately 4 hours. However, it is recommended that the batteries charge for 48 hours after long-term storage.

1.3.3 Time to Replace Batteries

When the discharging time is less than 50% of specified after full charged, the battery may need to be replaced. Please check the battery connection or contact your local dealer to order new battery.



WARNING:

- Turn off the UPS and disconnect the utility power cord from the wall outlet.
- Servicing should be performed by qualified service personnel knowledgeable of batteries and required precautions. Keep unauthorized personnel away from batteries
- Batteries can present a risk of electrical shock or burn from high short circuit current. The following precautions should be observed:
 1. Remove watches, rings, or other metal objects.
 2. Use tools with insulated handles.
 3. Do not lay tools or metal parts on top of batteries.
 4. Wear rubber gloves and boots.
 5. Disconnect the charging source prior to connecting or disconnecting battery terminal.
- When replacing batteries, replace with the same type and number of batteries or battery packs. Contact your service representative to order new batteries.
- Do not dispose of battery in a fire. Batteries may explode when exposed to flame.
- Proper disposal of batteries is required. Refer to your local codes for disposal requirements.

- Do not open or mutilate the battery. Released toxic electrolyte is harmful to skin and eyes.

EN

Note: If you are not qualified service personnel to replace the battery, do not attempt to open the battery cabin. Please call local dealer or distributor immediately.

1.3.4 Replacing UPS Internal Batteries

Follow the steps and Charts as below to replace batteries:

1. Take off the LCD box, and remove the screws.
2. Slide and Pull the front panel leftward and then take it off.
3. Disconnect the cable from the UPS and battery pack.
4. Remove the right inner battery bracket.
5. Pull the battery pack out onto flat area.
6. Install new battery pack into UPS.
7. Screw up the battery bracket and reconnect the battery cable A and B
8. Re-install the front panel back to UPS.

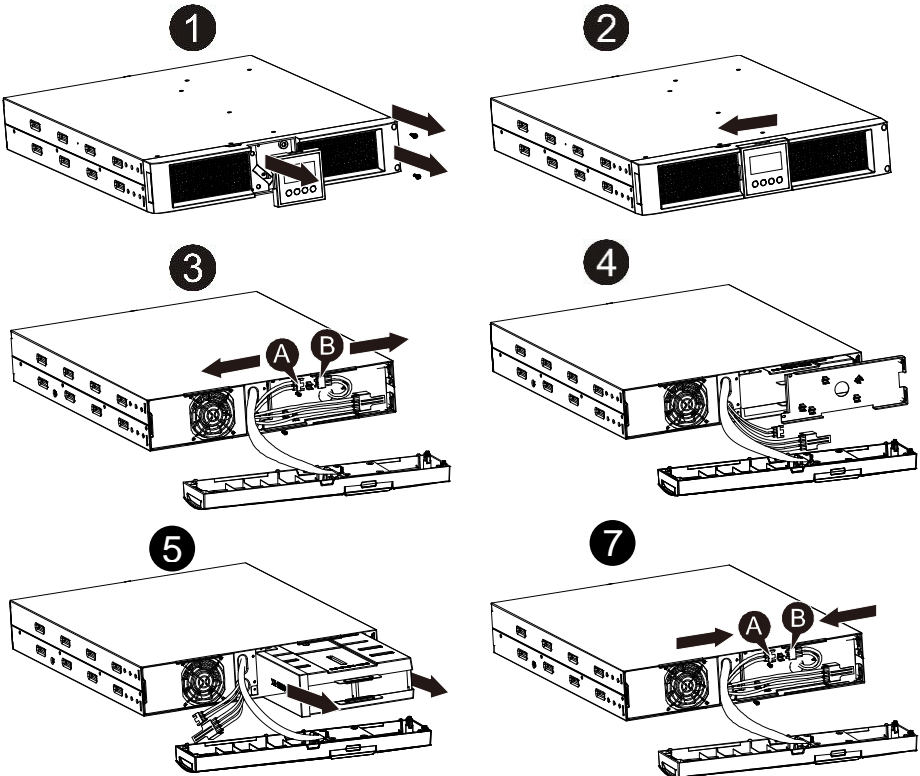

1.3.5 Testing New Batteries

For a battery test, please check:

- The batteries must be fully charged.
- The UPS must be in Normal mode with no active alarms.
- Don't take on/off the load.

To test batteries:

1. Connect the UPS to utility power for at least 48 hours to charge the batteries.
2. Press and hold the “I” button 1 second to start the battery test on line mode or HE mode. The status display string shows “TEST”

1.3.6 Recycling the Used Battery:



Warning:

- Never dispose the batteries in a fire. It may explode.
- Do not open or mutilate the batteries. Released electrolyte is harmful to the skins and eyes. It may be toxic. A battery can present a risk of electrical shock and high short circuit current.

To recycle properly the used battery, please do not discard the UPS, battery pack and batteries into the trash bin. Please follow your local laws and regulations; you may contact your local recycling waste management center for further information to dispose properly of the used UPS, battery pack, and batteries.

1.4 Transport

- ★ Please transport the UPS only in the original packaging (to protect against shock and impact).

1.5 Storage

- ★ The UPS must be stockpiled in the room where it is ventilated and dry.

1.6 Standards













EN

* Safety	
IEC/EN 62040-1	
* EMI	
Conducted Emission.....:IEC/EN 62040-2	Category C1
Radiated Emission.....:IEC/EN 62040-2	Category C1
Harmonic Current.....:IEC/EN 61000-3-2	
Voltage Fluctuation and Flicker.....:IEC/EN 61000-3-3	
*EMS	
ESD.....:IEC/EN 61000-4-2	Level 3
RS.....:IEC/EN 61000-4-3	Level 3
EFT.....:IEC/EN 61000-4-4	Level 4
SURGE.....:IEC/EN 61000-4-5	Level 4
CS.....:IEC/EN 61000-4-6	Level 3
MS.....: IEC/EN 61000-4-8	Level 3
Voltage Dips.....: IEC/EN 61000-4-11	
Low Frequency Signals.....:IEC/EN 61000-2-2	

2. Description of Commonly Used Symbols

Some or all of the following symbols may be used in this manual. It is advisable to familiarize yourself with them and understand their meaning:

EN

Symbol and Explanation			
Symbol	Explanation	Symbol	Explanation
	Alert you to pay special attention		Protective ground
	Caution of high voltage		Alarm silence
	Turn on the UPS		Overload indication
	Turn off the UPS		Battery
	Idle or shut down the UPS		Recycle
	Alternating current source (AC)		Do not dispose with ordinary trash
	Direct current source (DC)		

3. Introduction

This On-Line-Series is an uninterruptible power supply incorporating double-converter technology. It provides perfect protection specifically for Novell, Windows NT and UNIX servers.

The double-converter principle eliminates all mains power disturbances. A rectifier converts the alternating current from the socket outlet to direct current. This direct current charges the batteries and powers the inverter. On the basis of this DC voltage, the inverter generates a sinusoidal AC voltage, which permanently supplies the loads.

Computers and periphery are thus powered entirely by the mains voltage. In the event of power failure, the maintenance-free batteries power the inverter.

This manual covers the UPS listed as follows. Please confirm whether it is the model you intend to purchase by performing a visual inspection of the Model No. on the rear panel of the UPS.

Model No.	Type	Model No.	Type
1K	Standard	1KS	Extended backup time
1.5K		1.5KS	
2K		2KS	
3K		3KS	

“S” Model: Extended backup time

4. Panel Description

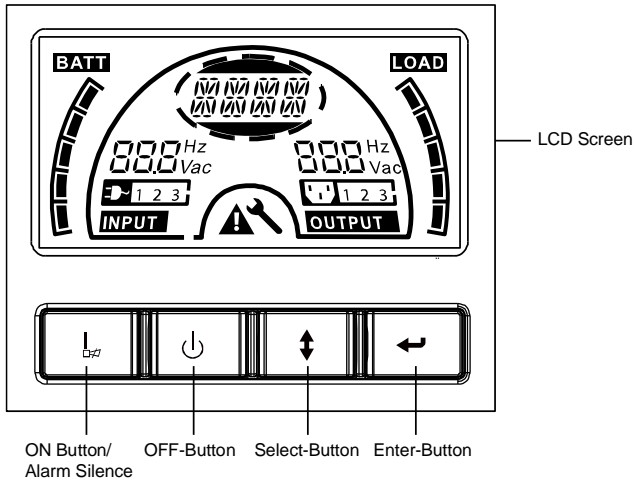

The Display Panel

Switch	Function
ON-Button	<p>Turn on UPS system: By pressing the ON-Button “I” the UPS system is turned on.</p> <p>Deactivate acoustic alarm: By pressing this Button an acoustic alarm can be deactivated in the battery mode. By short touch this Button all acoustic alarms can be deactivated in all mode.</p> <p>Do the battery test: By pressing this Button the UPS can do the battery test in the Line mode or ECO mode or Converter mode.</p>
OFF-Button	<p>When mains power is normal, the UPS system switches to No output or Bypass mode by pressing OFF-Button “⏏”, and the inverter is off. At this moment, if Bypass is enabled, then the output sockets are supplied with voltage via the bypass if the mains power is available.</p> <p>Deactivate acoustic alarm: By pressing this Button an acoustic alarm can be deactivated in the bypass mode.</p> <p>Release the UPS from fault mode and EPO status.</p>
Select-Button	<p>The output voltage, frequency, Bypass disable/enable and operating mode in No output or Bypass mode, Two Load segments in output mode, The number of EBM in all mode, could be selected by pressing Select-Button, and confirmed by pressing Enter-Button.</p>
Enter-Button	

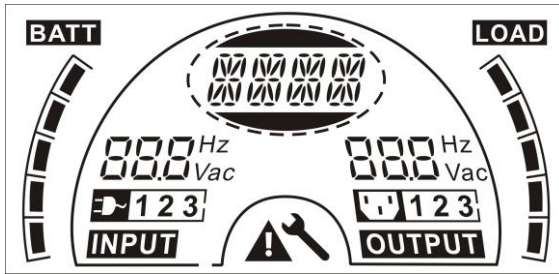
The LCD Display

Display	Function	Display	Function
Input Information		Output Information	
	It indicates input voltage/frequency value, which are displayed alternately.		It indicates output voltage/frequency value, which are displayed alternately.
	It indicates the input is connected with mains, and the input power is supplied from the mains.		It indicates the Output plug.
1 2 3	It indicates the Number of the input supplied from the mains.	1 2 3	It indicates the Number of the output connected with load.
Battery Information		Load Information	
	It indicates the battery capacity. Every grid represents the capacity of 20%.		It indicates the load level. Every grid represents the level of 20%.
Mode/Fault/Warning Information		Else	
	It Indicates the operating mode or Fault kind or Warning kind, several warning kinds at the same time could be displayed alternately.		It indicates the UPS is in setting mode.
			It indicates the UPS is in Fault mode or has some warnings.

5. Connection and Operation

The system may be installed and wired only by qualified electricians in accordance with applicable safety regulations!

When installing the electrical wiring, please note the nominal amperage of your incoming feeder.

5.1 Inspection

Inspect the packaging carton and its contents for damage. Please inform the transport agency immediately should you find signs of damage.

Please keep the packaging in a safe place for future use.

Note: Please ensure that the incoming feeder is isolated and secured to prevent it from being switched back on again.

5.2 Connection

(1) UPS Input Connection

If the UPS is connected via the power cord, please use a proper socket with protection against electric current, the user can refer to below table. If the UPS is connected via wires, it is recommended to select the 2.5mm² wire, and the “GND” terminal should be grounded first.

The UPS System has no input breaker on the standard cabinet. When installing the UPS, the user needs to connect the external breakers and protective components in the input terminals. It is recommended to select the NFB(Non-Fuse Breaker) instead of the traditional combination kit including breaker and fuse.

When selecting the NFB, the user can refer to below table.

Model No.	UPS INPUT NFB & Power Cord & Socket	
	VOLTAGE	CURRENT
1K(S)	300Vac	10A
1.5K(S)	300Vac	12A
2K(S)	300Vac	16A
3K(S)	300Vac	20A

(2) UPS Output Connection

The output of the UPS is IEC socket-types. Simply plug the load power cord to the output sockets to complete connection. Use one cord for every 5A load.

Model No.	Output Socket (pcs)
1K(S)/1.5K(S)/ 2K(S)	8 * IEC320 C13
3K(S)	8 * IEC320 C13 + 1 * C19

The wiring configuration is shown as the following procedure:

- Remove the small cover of the terminal block
- Use 2.5mm² wires for wiring configuration
- Upon completion of the wiring configuration, please check whether the wires are securely affixed
- Put the small cover back to the rear panel

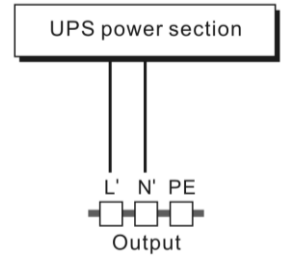

Connection diagram



Caution:

Do not connect equipment which would overload the UPS system (e.g. laser printers)

(3) EPO Connection:

User can select the polarity of EPO, EPO is Normally open as default setting.

- NO

Normally the EPO connector is open on the rear panel. Once the connector is closed with a wire, the UPS would stop the output until the EPO status is disabled.

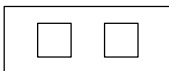

Disable the EPO status

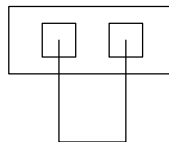

Enable the EPO status

- NC

Normally the EPO connector is closed with a wire on the rear panel. Once the connector is open, the UPS would stop the output until the EPO status is disabled.

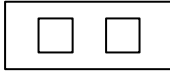

Enable the EPO status

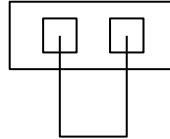

Disable the EPO status

5.3 Battery charge

Fully charge the batteries of the UPS system by leaving the UPS system connected to the mains for 12 hours. You may use the UPS system directly without charging it but the stored energy time may be shorter than the nominal value specified.

5.4 Turn on the UPS

(1) With utility power connecting:

Press “I” button continuously for more than 1 second to turn on the UPS, the UPS will get into the inverter mode, the LCD screen will indicate the state of the UPS.

(2) Without utility power connecting:

If UPS is cold start without utility power connecting, user need to push “I” button twice, first pushing “I” button is for UPS to get power, LCD screen show ‘INIT’. And second pushing “I” button continuously for more than 1 second is for UPS to turns on, the UPS will get into the inverter mode. In fact, the two pushing “I” button is to make further sure user operation for turning on UPS, the LCD screen will indicate the state of the UPS.

Note: The default setting for bypass mode is no output after UPS is connecting utility power and breaker is turned on. This can be configured by monitoring the LCD panel or firmware.

5.5 Test function

(1) Real time detection

UPS could do real-time detection when battery connected or disconnected. If the battery connection status is changed, in floating mode, UPS will detect the change within 30 seconds; in resting mode, UPS will detect the change within 3 minutes;

(2) Manual test

Test the function of the UPS system by pressing the On-Switch “I” for more than 1 second, the UPS would detect whether the battery is connected or the battery is low immediately. Also the UPS could do the test automatically and periodically, the period time could be set by user, the default value is 7 days.

5.6 Turn off the UPS

(1) In Inverter Mode:

Press “” button continuously for more than 1 second to turn off the UPS, the UPS will get into no output or bypass mode. At this time, the UPS might has output if bypass is enabled. Disconnect the utility power to turn off the output.

(2) In Battery Mode:

Press “” button continuously for more than 1 second to turn off the UPS, the UPS will be turned off completely.

5.7 Audible alarm mute function

If the alarm is too annoying in battery mode, you may press “I” button continuously for more than 1 second to clear it. Moreover, the alarm will be enabled when the battery is low to remind you to shutdown the load soon.

If the alarm is too annoying in bypass mode, you may press “” button continuously for more than 1 second to clear it. The action doesn't affect the warning and fault alarm.

If all alarm is too annoying, you can short touch “I” button, all alarms are disable, if alarms need to be resumed, short touch “I” button again.

5.8 Operation procedure of external battery for long backup time model (“S” model)

- (1) Use the battery pack with voltage: 36VDC for 1KS (12V×3 batteries), 48VDC for 1.5KS/ 2KS (12V×4 batteries), 72VDC for 3KS (12V×6 batteries). Connection of batteries more than or less than required will cause abnormality or permanent damage.

- (2) One hard wiring type battery terminal on the rear panel is used for connecting the battery pack.
- (3) The battery connection procedure is very important. Any incompliance may result in the risk of electric shock. Therefore, the following steps must be strictly complied with.
- (4) Make sure the mains input is cut off, if there is a battery breaker then turn it off first.
- (5) Remove front panel, connect the battery via Anderson PP45 connectors. Prepare the battery cable which should be able to carry the current of >50A for all models, the cross section area should be great than 4 mm² for all model. And battery wire color is recommended as following:

+	GND	-
Red wire	Green/Yellow wire	Black wire

- (6) The red wire is connected to the "+" terminal of the battery. The black wire is connected to the "-" terminal of the battery. (Note: the green/yellow wire is grounded for protection purpose.)
- (7) Make sure the wires are fasten, install the terminal block cover on the rear panel of the UPS.
- (8) Connect the UPS to the load. Then, turn on the mains switch or connect the power cord of the UPS to utility power supply, the battery would start to be charged.



Caution:

A DC breaker must be connected between the UPS and external battery.



Caution:

The output sockets of the UPS system may still be electrically live even if the power supply system has been disconnected or the Bypass switch is on "OFF" position.

6. Operating Mode for All Models

The different string could be displayed on the LCD screen corresponding to their own operating modes, and they are illustrated as the following table. At any time, only one normal operating string or fault string is presented. But the warning, even several warnings could appear in a certain normal operating mode at one time. And the normal operating mode string and the warning string would be shown circularly. Once one fault is come forth, then all previous warnings would not be shown again but only the fault string is presented.

Normal operating mode	Code
No output mode	STbY
Bypass mode	bYPA
Line mode	LINE
Battery mode	bATT
Battery test mode	TEST
ECO mode	ECO
Converter mode	CVCF

6.1 Line mode

The LCD display in Line mode is shown in the following diagram. The information about the utility power, the battery level, the UPS output and the load level could be displayed. The “LINE” string indicates the UPS is working in Line mode.

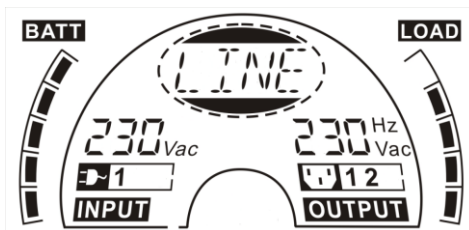

■ The Line mode

If output overloaded, alarm will keep twice every second. You should get rid of some unnecessary loads one by one to decrease the loads connected to the UPS less than 90% of its nominal power capacity.

Note: Please follow the following steps to connect the generator:

- Activate the generator and wait until the operation is stable before supplying power of the generator to the UPS (be sure that the UPS is in idle mode). Then turn on the UPS according to the start-up procedure. After the UPS is turned on, then the loads can be connected to the UPS one by one.
- The power capacity of the AC generator should be at least twice of the UPS capacity.

6.2 Battery mode

The LCD display in battery mode is shown in the following diagram. The information about the utility power, the battery level, the UPS output and the load level could be displayed. The “bATT” string indicates the UPS is working in the battery mode.

When the UPS is running in battery mode, the buzzer beeps once every 4 seconds. If the “ON” button on the front panel is pressed for more than 1 second again, the buzzer will stop beeping (in silence mode). Press the “ON” button once again for more than 1 second to resume the alarm function.



■ The Battery mode

6.3 Bypass mode

The LCD display in bypass mode is shown in the following diagram. The information about the utility power, the battery level, the UPS output and the load level could be displayed. The UPS will beep once every 2 minutes in bypass mode. The “bYPA” string indicate the UPS is working in the bypass mode.

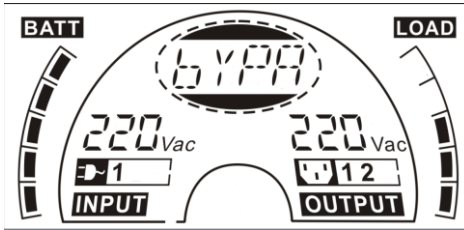

■ The Bypass mode

The UPS does not have the backup function when it is in bypass mode. The power used by the load is supplied from the utility power via internal filter.

6.4 NO output mode

The LCD display in No output mode is shown in the following diagram. The information about the utility power, the battery level, the UPS output and the load level could be displayed. The "STbY" string indicates the UPS is working in the No output mode.

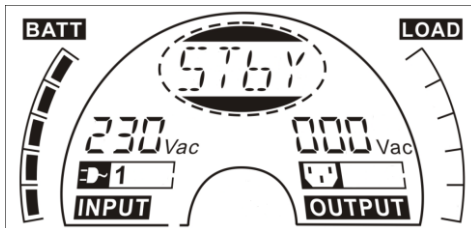

■ The No output mode

6.5 EPO (Emergency Power Off)

It is also called RPO (Remote Power Off). On LCD display, the mode string is "EPO".

It is a special status in which the UPS would shut the output off and alarm. The UPS could not be turned off by pressing "OFF" button on the panel, only after releasing EPO status by turning off the EPO switch.

6.6 ECO mode (Economy mode)

It is also called high efficiency mode. In ECO mode, on LCD display, the mode string is "ECO".

After the UPS is turned on, the power used by the load is supplied from the

utility power via internal filter while the utility power is in normal range, so the high efficiency could be gained in the ECO mode. Once the mains is loss or abnormal, the UPS would transfer to battery mode and the load is supplied continuously by the battery.

- 1) It could be enabled through the LCD setting or the software (Winpower, etc.).
- 2) It is attention that the transfer time of UPS output from ECO mode to battery mode is less than 10ms. But it is still too long for some sensitive load.

6.7 Converter mode

In converter mode, on LCD display, the mode string is “CVCF”.

The UPS would free run with fixed output frequency (50Hz or 60Hz) in converter mode. Once the mains is loss or abnormal, the UPS would transfer to battery mode and the load is supplied continuously by the battery.

- 1) It could be enabled through the LCD setting or the software (Winpower, etc.).
- 2) The load should be derating to 70% in converter mode.

6.8 Abnormal mode

In abnormal mode such as Bus fault etc., the corresponding fault string would be shown to indicate the operating mode of the UPS, and the background light become red. For example “SHOR” would be shown when the load or the UPS output is short. The LCD display is shown in the following diagram.

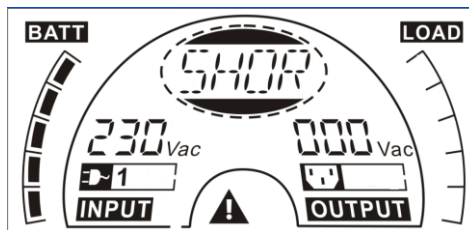

7. Setting by LCD Module

The output voltage, frequency, Bypass status and operating mode in No output mode or Bypass mode, Two Load segments in output mode, The number of EBM in all mode could be set directly through LCD module. The output voltage could be set to 208V, 220V, 230V and 240V. The output frequency could be set to 50Hz and 60Hz. The bypass state could be set to enable and disable. The operating mode of UPS could be set between the Line mode, ECO mode and Converter mode. The number of EBM could be set to 0 to 9. Two Load segments could be set to on and off.

In bypass or no output mode, pressing the “Enter” button on the LCD panel for more than one second to enter setting mode. The LCD display is shown in the following diagram. The string “OPV” indicates that the current setting is output voltage. “230Vac” indicates the current default output voltage is 230Vac. if you want to set output voltage, press the “Enter” button for more than one second, a flickering string “208” would be shown, if the “Enter” button is pressed again, the string “208” turn to flickerless, the output volt is changed to 208V; if the “Select” button is pressed for more than one second, the next flickering string “220” appear, the order of flickering string is 208 – 220 – 230 – 240 – 208, Press “Enter” button to confirm the output volt what you want.

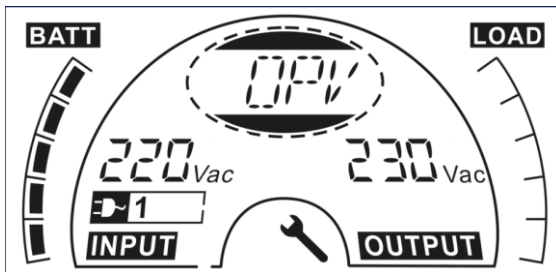

Exit the setting mode to short touch the “Enter” button; continue setting to press “Select” button. if no any pressing on the “Select” or “Enter” button lasting for more than 10 seconds, the setting mode exit automatically.

The output frequency string “OPF”, Bypass status string ” bYPA”, operating mode string “MOdE”, EBM string EbM, Load segment string “LS1” and “LS2” would be presented circularly. The only one voltage value could be selected in “208V”, “220V”, “230V”, “240V” at any time; The only one frequency value could be selected in “50Hz”, “60Hz” at any time; Bypass status could be selected in “000” or “001”(Here 000 means Bypass Disable,001 means

Bypass Enable), The UPS would turn to bypass mode in several seconds after “Bypass Enable” is selected, and turn to no output mode in several seconds after “Bypass Disable” is selected; Operating mode could be selected in “UPS”, “ECO”, “CVF”(Here “UPS” means the normal inverter mode, “ECO” means the high efficiency mode, and “CVF” means the converter mode), The mode change would be active only after the UPS is turned on; The number of EBM could be selected in “000” to “009”(Here “000” means no EBM connected). Load segment 1 could be selected in “000” or “001”(Here 000 means load segment 1 off, 001 means load segment 1 on); Load segment 2 is the same as Load segment 1.

■ Here is a example for changing the Operating mode from normal mode to converter mode through the LCD panel.

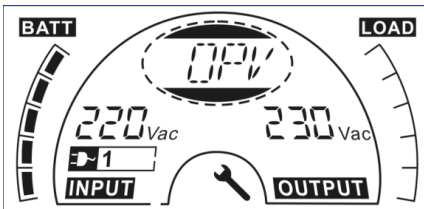

Step 1: “OPV” after pressing the “Enter” button;

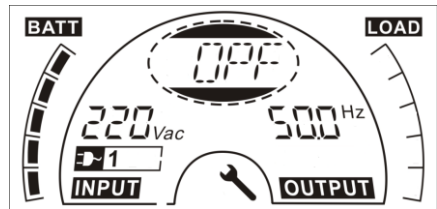

Step 2: “OPF” after pressing the “Select” button.

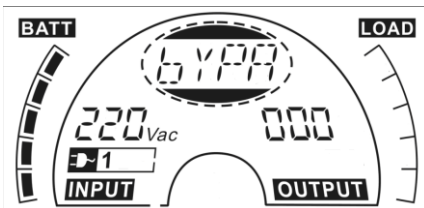

Step 3: “bYPA” after pressing the “Select” button;

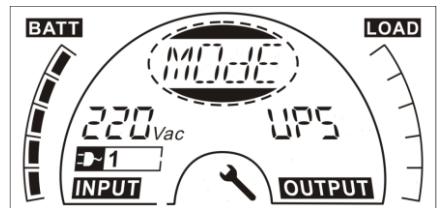

Step 4: “MOdE” after pressing the “Select” button, press the “Enter” button to set mode, then “UPS” flickering;

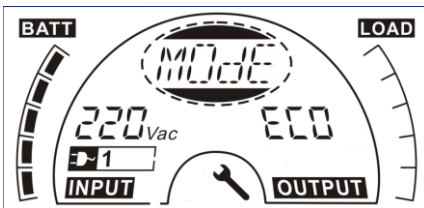

Step 5: “ECO” flickering after pressing button the “Select” button;

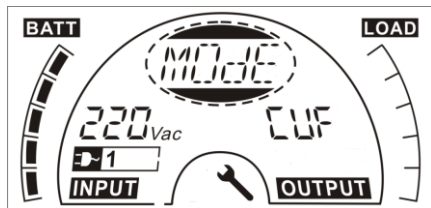

Step 6: “CVF” flickering after pressing the “Select” again. Press the “Enter” button to make sure to change the mode. Short touch “Enter” button to exit setting mode.

8. Trouble Shooting

If the UPS system does not operate correctly, check the operating status on the LCD display.

EN

Warning	String	Fault	String
Site fail	SITE	Inverter short	SHOR
Fan fail	FANF	Overload fault	OVLD
Battery over voltage (over charged)	HIGH	Inverter soft start fail	ISFT
Battery low	bLOW	Bus soft start fail	bSFT
Charge fail	CHGF	Over temperature fault	OVTP
Inverter temperature high	TEPH	Inverter voltage low	INVL
Ambient temperature high	AMbH	Inverter voltage high	INVH
Battery open	bOPN	Bus voltage over	bUSH
Overload	OVLD	Bus voltage Low	bUSL
EPO	EPO	Bus voltage unbalance	bUSE
Battery fault	bATF	Bus short	bUSS
		NTC open	NTCO

If the UPS system does not operate correctly, please attempt to solve the problem using the table below.

Problem	Pzle cause	Remedy
No indication, no warning tone even though system is connected to mains power supply	No input voltage	Check building wiring socket outlet and input cable.
Display Mode string "STbY" in LCD, even though the power supply is available	Inverter not switched on	Press On-Switch "I".
Display Mode string "bATT" in LCD, and audible alarm sounding every 1 beep in every 4 seconds	Mains power supply has failed, or Input power and/or frequency are out of tolerance	Switching to battery mode automatically. Check input power source and inform dealer if necessary.
Emergency supply period shorter than nominal value	Batteries not fully charged / batteries defect	Charge the batteries for at least 5 - 8 hours and then check capacity. If the problem still persists, consult your dealer.
Fan fail	Fan abnormal	Check if the fan is running

Battery over voltage	Battery is over charged	Stop charging to battery automatically, and after the battery voltage is normal and the mains is normal, charge automatically again.
Battery low	Battery voltage is low	When audible alarm sounding every second, battery is almost empty.
Charge fail	The charge is broken	Notify dealer.
Inverter temperature high	Inside temperature of the UPS is too high	Check the ventilation of the UPS, check the ambient temperature.
Ambient temperature high	The ambient temperature is too high	Check the environment ventilation.
Battery open	Battery pack is not connected correctly	Check the battery bank is connected to the UPS. Check the battery breaker is turn on.
Battery fault	Battery may need to be replaced	Notify dealer
Overload	Overload	Check the loads and remove some non-critical loads. Check whether some loads are failed.
Site fail	Phase and neutral conductor at input of UPS system are reversed	Rotate mains power socket by 180° or connect UPS system.
EPO active	EPO function is enabled	Turn off the EPO switch.
Bus fault(Low/high/Unbalance/soft start)	UPS internal fault	Notify dealer
Inverter fault(Low/high/soft start)	UPS internal fault	Notify dealer
Over temperature fault	Over temperature	Check the ventilation of the UPS, check the ambient temperature and ventilation.
NTC open	UPS internal fault	Notify dealer
Inverter short	Output short circuit	Remove all the loads. Turn off the UPS. Check whether the output of UPS and loads is short circuit. Make sure the short circuit is removed, and the UPS has no internal faults before turning on again.
Bus short	UPS internal fault	Notify dealer

Please have the following information at hand before calling the After-Sales Service Department:

1. Model number, serial number
2. Date on which the problem occurred
3. LCD display status, Buzzer alarm status
4. Utility power condition, load type and capacity, environment temperature, ventilation condition
5. The information (battery capacity, quantity) of external battery pack if the UPS is "S" model
6. Other information for complete description of the problem

9. Maintenance

9.1 Operation

The UPS system contains no user-serviceable parts. If the battery service life (3–5 years at 25°C ambient temperature) has been exceeded, the batteries must be replaced. In this case please contact your dealer.

9.2 Storage

If the batteries are stored in temperate climatic zones, they should be charged every three months for 1–2 hours. You should shorten the charging intervals to two months at locations subject to high temperatures.

9.3 Battery Replace

If the battery service life has been exceeded, the batteries must be replaced.

Battery replacement should be performed only by qualified personnel.

It recommends to shut off the UPS completely before the replacement. If there is a battery breaker then turn it off first. Disconnect the battery cable carefully and make sure no any exposed wires can be touched. Reconnect the new batteries to the UPS by following section 5.8. Then turn on the battery breaker and start the UPS.

If it needs to replace the batteries while the UPS is running, make sure the UPS would not shut down during the replacement. If there is a battery breaker then turn it off first. Disconnect the battery cable carefully and make sure no any exposed wires can be touched. Reconnect the new batteries to the UPS by following section 5.8. Then turn on the battery breaker and press the ON switch to make the UPS do the battery test, check whether the battery information is normal.

10. Technical Data

10.1 Electrical specifications

INPUT				
Model No.	1000	1500	2000	3000
Phase	1			
Frequency	(45~55)/(54~66) Hz			
Max Current(A)	7.5	10.5	13.5	20
OUTPUT				
Model No.	1K(S)	1.5K(S)	2K(S)	3K(S)
Power rating	1kVA/0.9kW	1.5k/1.35kW	2kVA/1.8kW	3kVA/2.7kW
Voltage	208/220/230/240 × (1 ± 1%) VAC			
Frequency	50/60 (±0.2) Hz (Battery mode)			
Wave form	sinusoidal			
BATTERIES				
Model No.	1K	1.5K	2K	3K
Number and type	3 × 12V 7Ah	4 × 12V 7Ah	4 × 12V 9Ah	6 × 12V 9Ah

10.2 Operating Environment

Ambient Temperature	0°C to 40°C
Operating humidity	< 95%
Altitude	< 1000m
Storage temperature	0°C to 45°C

10.3 Typical backup time (Typical values at 25°C in minutes:)

Model No.	100 % Load	50 % Load
1K	5	15
1.5K	4	12
2K	3	10
3K	3	10

10.4 Dimensions and weights

Model		1000	1000S	1500	1500S	2000	2000S	3000	3000S	
UPS Case	Net weight (kg)	16.2	8.4	19.7	9.3	19.7	9.3	28.6	13.2	
	Dimension (mm) (W x H x D)	438X86.5x436						438X86.5x608		
EBM Case	Dimension (mm) (W x H x D)	438X86.5x436						438X86.5x608		
	Net weight (kg)	22.2		27.5			40.5			
	Type	36V		48V			72V			

EN

11. Communication Port

11.1 RS-232 and USB communication ports

To establish communication between the UPS and a computer, connect a computer to one of the UPS communication ports by using an applicable communication cable.



NOTE:

Only one of the communication ports can be active at one time. The USB port has priority over the RS-232 port.

When a communication cable is installed, the power management software can exchange data with the UPS. The software polls the UPS for detailed information on the status of the power environment. If a power emergency occurs, the software initiates the saving of all data and an orderly shutdown of the equipment

11.2 RS-232 port

The RS-232 port is available for UPS monitoring, control, and firmware updates. To establish communication between the UPS and a computer, connect one end of the serial communication cable that comes with the UPS to the RS-232 port on the UPS. Connect the other end of the serial cable to the RS-232 port on a computer.

The cable pins for the RS-232 communication port are identified in the following illustration.

RS-232 communication port pin assignments

Pin	Signal name	Function	Direction from the UPS
1		Unused	Not applicable
2	Tx	Transmit to external device	Out
3	Rx	Receive from external device	In
4		Unused	Not applicable
5	GND	Signal common (tied to chassis)	Not applicable
6		Unused	Not applicable
7		Unused	Not applicable
8		Unused	Not applicable
9		Unused	Not applicable

11.3 USB port

The UPS can communicate with a USB-compliant computer by using HID-compatible power management software. To establish communication between the UPS and a computer, connect the USB cable that comes with the UPS to the USB port on the UPS. Connect the other end of the USB cable to the USB port on a computer.

11.4 Installing a Serial Network Management Card (optional)

Each UPS has one available communication bay, which supports the optional Serial Network Management Card. After you install a Serial Network Management Card, you can connect an environmental monitoring probe to the UPS.

Note: You do not have to shut down the UPS before you install a communication card.

To install the Network Management Card, complete the following steps:

1. Locate the UPS communication bay.
2. Remove the two screws that secure the communication bay cover to the UPS and save the screws.
3. Insert the Serial Network Management Card into the slot on the UPS.
4. Secure the Serial Network Management Card to the UPS with both screws.

For more information about the Serial Network Management Card, see the Serial Network Management Card User's Guide.

11.5 Dry Contact port

The UPS incorporates build-in single programmable relay output with potential free contact for remote alarm indication: Dry out port; And incorporates single signal input: Dry in port. See figure in the UPS rear panel for the locations of the ports.

The relay output can be configured by protocol command setting, the default output contact is "Summary Alarm"; The signal input to control UPS On/Off status does not need to be configured, its function is the same as one button to control UPS On/Off status.

Note: The relay output contact must not be connected to any utility connected circuits. Reinforced insulation to the utility is required. The relay output contact has a maximum rating of 30Vac/1A and 60Vdc/2A normal values.

The following figures show schematic of the dry out/in contacts.

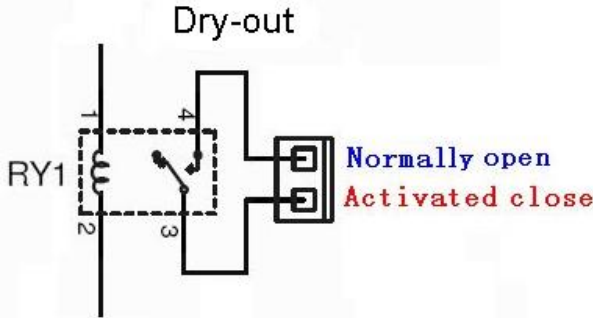

Dry out contact schematic

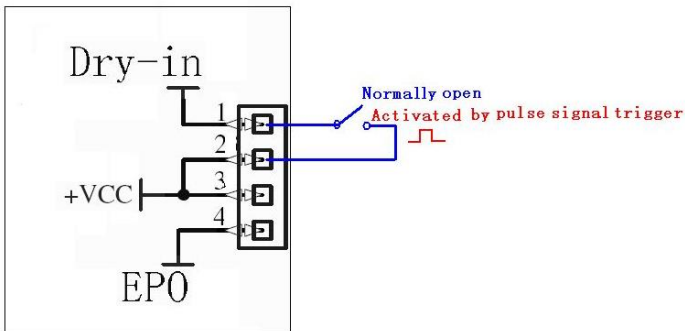

Dry in contact schematic

The following table shows the options for the dry out/in contacts

Dry out signal	Description
Summary Alarm	Activated when any warning happens
On Battery	Activated when the UPS operates on battery
Battery Low	Activated with the "bLOW" alarm
UPS ok	Activated when the UPS has no alarms and no fault.
On Bypass	Activated when the UPS has bypass output.
Dry in signal	Description
UPS On/Off	One second pulse activate, if active, the UPS turns off when UPS is on inverter; the UPS turns on when UPS is not on inverter. It is the same as a remote button to control UPS On/Off status.

12. Software Installation

This series is equipped with HID support for USB port. A Human Interface Device (HID) is a common class for Operating Systems. Devices supporting HID are automatically detected and immediately available for management on Windows, MacOS, Linux and other systems without installing additional software. Models with HID support are the best choice for all applications that do not allow installing monitoring software, but supports USB-HID like NAS, ATMs, Kiosks, surveillance video recording systems, specific industrial and office applications.

You can also use WinPower which is UPS monitoring software, featuring user-friendly interface to monitor and control your UPS. This unique software provides complete power protection for computer system while power failure. With the software users can monitor any UPS status on the same LAN. Furthermore, a UPS can provide security protection for more than one computer on the same LAN at the same time, such as shutting down system in security, saving application data and shutting down the UPS when power fails.

Software Installation on your PC:

Connected by USB to a PC or notebook, the Software enables communication between the UPS and the computer. The UPS software monitors the status of the UPS, shuts down the system before the UPS is exhausted and can remotely observe the UPS via the Network (enabling users to manage their system more effectively). Upon AC failure or UPS battery low, UPS takes all necessary actions without intervention from the system administrator. In addition to automatic file saving and system shut-down functions, it can also send warning messages via pager, e-mail etc.

- Use the bundled CD and follow the on-screen instructions to install the software WinPower.
- Enter the following serial No. to install software:
511C1-01220-0100-478DF2A
- After the software is successfully installed, the communication with UPS has been established and an green icon will appear in the system tray.

- Double-click the icon to use the monitor software (as above).
- You can schedule UPS shutdown/start-up and monitor UPS status through PC.
- Detail instructions please refer to the e-manual in the software.

 Check <http://winpower.powerwalker.com> from time to time to get the latest version of monitoring software.

Appendix: Rear panel

The UPS rear panel description table and pictures are shown as below:

No.	Function(1000VA &1500VA&2000VA&3000VA)
1	AC Output
2	EPO / Dry in Communication Port
3	USB Port
4	AC Input
5	Dry out
6	SNMP slot
7	RS232
8	Modem/Network Surge Protection
9	Earth Line Port

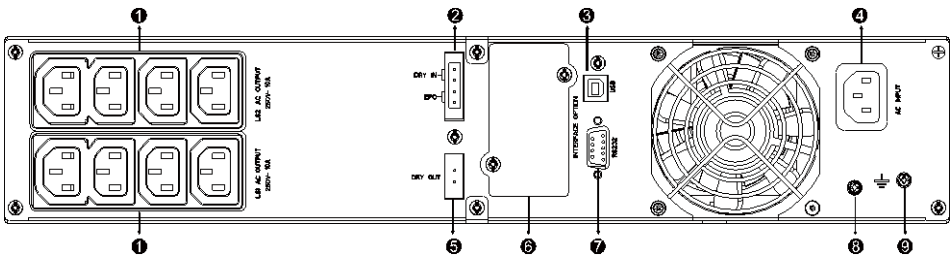

**1000VA /1500VA/2000VA Standard
& 1000VA /1500VA Super charger model rear panel**

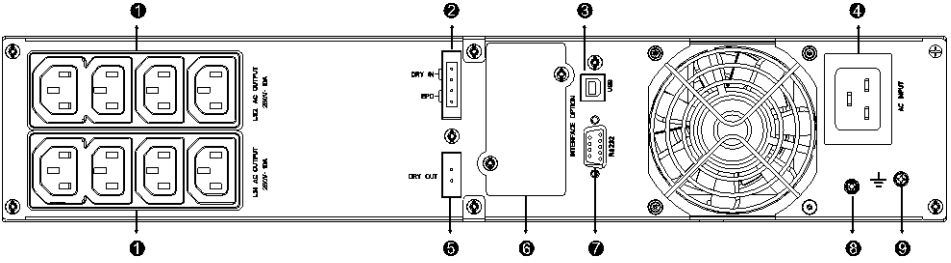

2000VA Super charger model rear panel

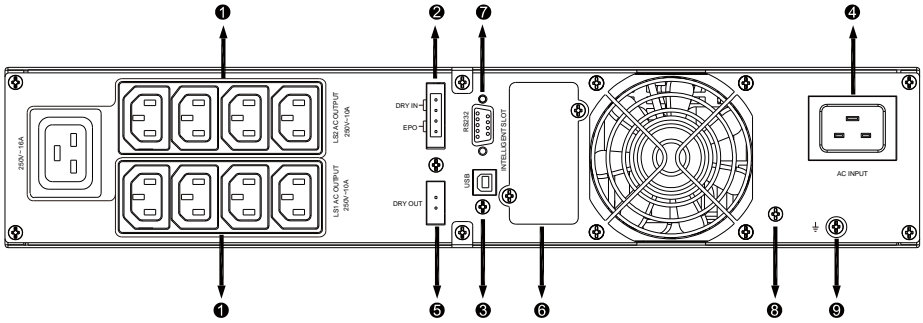

3000VA Standard model rear panel

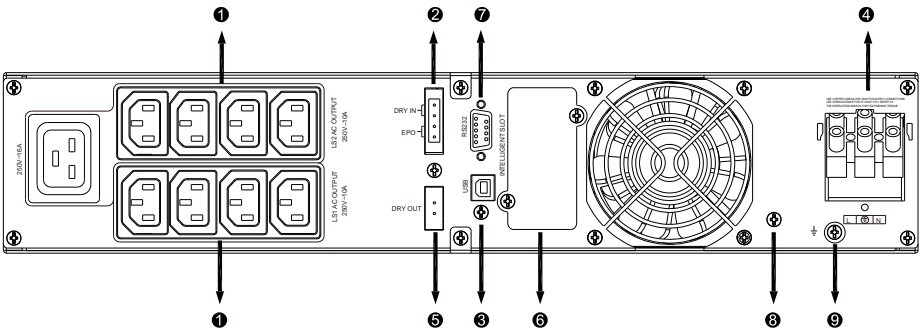

3000VA Super charger model rear panel

The EBM rear panel description table and picture are shown as below:

No.	Function(36V &48V & 72V EBM)
1	Earth Line Port

EN

