

VFI CPG PF1 3/3

(400V)

100K/ 120K/ 180K/ 200K

Online UPS

User Manual

Uninterruptible Power Supply System



Please comply with all warnings and operating instructions in this manual. This equipment should only be installed, serviced, and maintained by qualified personnel. Do not operate this unit before reading through all safety information and operating instructions carefully.

Disclaimer

We assume no responsibility or liability for loss or damages, whether direct, indirect, consequential or incidental, which might arise out of the use of such information. The use of any such information will be entirely at the user's risk. Information in this manual is subject to change without notice. We make no commitment to update or keep current the information in this manual. If you find information in this manual that is incorrect, misleading, or incomplete, we would appreciate your comments and suggestions.

Table of Contents

1. SAFETY AND EMC INSTRUCTIONS	1
1-1. TRANSPORTATION AND STORAGE	1
1-2. PREPARATION	1
1-3. INSTALLATION	1
1-4.  CONNECTION WARNINGS	2
1-5. OPERATION	3
1-6. STANDARDS	3
2. INSTALLATION AND OPERATION	4
2-1. UNPACKING AND INSPECTION	4
2-2. WIRING TERMINAL VIEW	5
2-3. UPS POSITIONING	10
2-4. SINGLE UPS INSTALLATION	11
2-5. UPS INSTALLATION FOR PARALLEL SYSTEM	13
2-6. SOFTWARE INSTALLATION	15
3. OPERATIONS	16
3-1. INITIAL OPERATION	16
3-2. SCREEN DESCRIPTION	16
3-3. AUDIBLE ALARM	39
3-4. SINGLE UPS OPERATION	39
3-5. PARALLEL OPERATION	42
3-6. FAULT CODE	43
3-7. WARNING CODE	44
4. TROUBLE SHOOTING	45
5. STORAGE AND MAINTENANCE	46
5-1. STORAGE	46
5-2. MAINTENANCE	46
6. SPECIFICATIONS	47

1. Safety and EMC instructions

All safety instructions in this document must be read, understood and followed.

1-1. Transportation and Storage



Please transport the UPS system only in the original packaging to protect against shock and damage.



The UPS must be stored in the room where the temperature is well regulated. Ambient temperature should not exceed 40°C.

1-2. Preparation



Condensation may form if the UPS system is moved from cold to warm environment immediately. The UPS system must be absolutely dry before being installed. Please allow at least two hours for the UPS system to acclimate to the environment.



Do not install the UPS system near water or in moist environments.



Do not install the UPS system where it would be exposed to direct sunlight or nearby heat source.



Do not block ventilation holes on the UPS housing.

1-3. Installation



Do not connect appliances or devices which would overload the UPS (e.g. big motor-type equipment) to the UPS output terminal.



Place cables in such a way that no one can step on or trip over them.



Do not block air vents on the housing of the UPS. Ensure proper unit spacing of ventilation.



UPS equipped with grounding terminal, in the final installation phase, connect grounding/earthing wire to the external UPS battery cabinets or appropriate grounding terminals.



The UPS can be installed only by qualified maintenance personnel.



An appropriate disconnect device such as short-circuit backup protection should be incorporated during installation.



An integral emergency shutoff switch which prevents additional load from the UPS in any mode of operation should be implemented during the installation.



Secure the grounding/earthing wire before connecting to any live wire terminal.



Installation and Wiring must be in accordance with the local electrical laws and regulations.

1-4. Connection Warnings

- There is no standard backfeed protection inside of the UPS. However, there are relays on the Input to cut off line voltage and while the neutral is still connected to UPS.

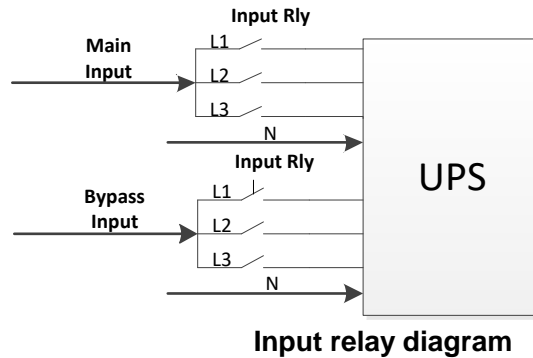

- This UPS should be connected with **TN** grounding/earthing system.
- The power input for this unit must be three-phase rated in accordance with the equipment nameplate. It also must be suitably grounded.

WARNING
HIGH LEAKAGE CURRENT
EARTH CONNECTION ESSENTIAL
BEFORE CONNECTING SUPPLY

- Use of this equipment in medical instrument of any life-sustaining equipment where failure of this equipment can reasonably be expected to cause the failure of the life-sustaining equipment or to significantly affect its safety or effectiveness is not recommended. Do not use this equipment in the presence of a flammable mixture with air, oxygen or nitrous oxide.
- Connect grounding terminal of UPS to a grounding electrode conductor.
- In accordance with safety standard EN-IEC 62040-1, installation has to be provided with a «Backfeed Protection» system, as for example a contactor, which will prevent the appearance of voltage or dangerous energy in the input mains during a mains fault (see figure 24 and respect the wiring diagram of «Backfeed Protection» depending if the equipment is with signal or three phase input).



There can be no derivation in the line that goes from the «Backfeed Protection» to the UPS, as the standard safety would be infringed.

- Warning labels should be placed on all primary power switches installed in places away from the unit to alert the electrical maintenance personnel of the presence of a UPS in the circuit. The label will bear the following or an equivalent text:

Before working on this circuit

- Isolate Uninterruptible Power Supply (UPS)
- Then check for Hazardous Voltage between all terminals including the protected earth

Risk of Voltage Backfeed



1-5. Operation



Do not disconnect the grounding/earthing conductor cable on the UPS or the building wiring terminals under any circumstance.



The UPS system features its own, internal current source (batteries). The UPS output sockets or output terminal blocks may be electrically live even if the UPS system is not connected to the building mains/live wires. (only for standard models)



In order to fully disconnect the UPS system, first press the "OFF" button and then disconnect the mains/live wires.



Ensure that no liquid or other foreign objects can enter into the UPS system.



The UPS can be operated by any individuals with no previous experience.

1-6. Standards

* Safety	
IEC/EN 62040-1	
* EMI	
Conducted Emission.....:IEC/EN 62040-2	Category C3
Radiated Emission.....:IEC/EN 62040-2	Category C3
*EMS	
ESD.....:IEC/EN 61000-4-2	CD Level 2 AD Level 3
RS..... :IEC/EN 61000-4-3	Level 3
EFT..... :IEC/EN 61000-4-4	Level 3
SURGE..... :IEC/EN 61000-4-5	Level 3
CS..... :IEC/EN 61000-4-6	Level 3
Power-frequency Magnetic field..... :IEC/EN 61000-4-8	Level 4
Low Frequency Signals.....:IEC/EN 61000-2-2 10V	
Warning: This is a product for commercial and industrial application in the second environment-installation restrictions or additional measures may be needed to prevent disturbances.	

2. Installation and Operation

These series came with two VAC systems: 208V and 400V. There are two different types of models: standard and long-run models. Please refer to the following table.

VAC System	Model	Type	Model	Type
208V	LV15K	Standard model	LV 15KL	Long-run model
			LV 30KL	
			LV 50KL/ 60KL	
			LV 90KL/100KL	
400V	HV30K		HV 30KL	
			HV 60KL	
			HV100KL/120KL	
			HV 180KL/200KL	

We also offer optional parallel function. The UPS with parallel function is called the "Parallel model". We have detail installation and operation procedure of the Parallel Model in the following chapter.

2-1. Unpacking and Inspection

Unpack the package and check the package contents. The shipping package should contain:

- One UPS
- One user manual
- One monitoring software CD
- One RS-232 cable (option)
- One USB cable
- One parallel cable (only available for parallel model)
- One shared current cable (only available for parallel model)

NOTE: Before the installation, please inspect the unit. Be sure that there is no physical damage to the unit. Do not turn on the unit and notify the carrier and dealer immediately if there is any damage or missing parts and accessories. Please keep the original packaging for future use. It is recommended to keep each equipment and battery set in their original packaging because they have been designed to provide maximum protection during transportation and storage.

2-2. Wiring Terminal View

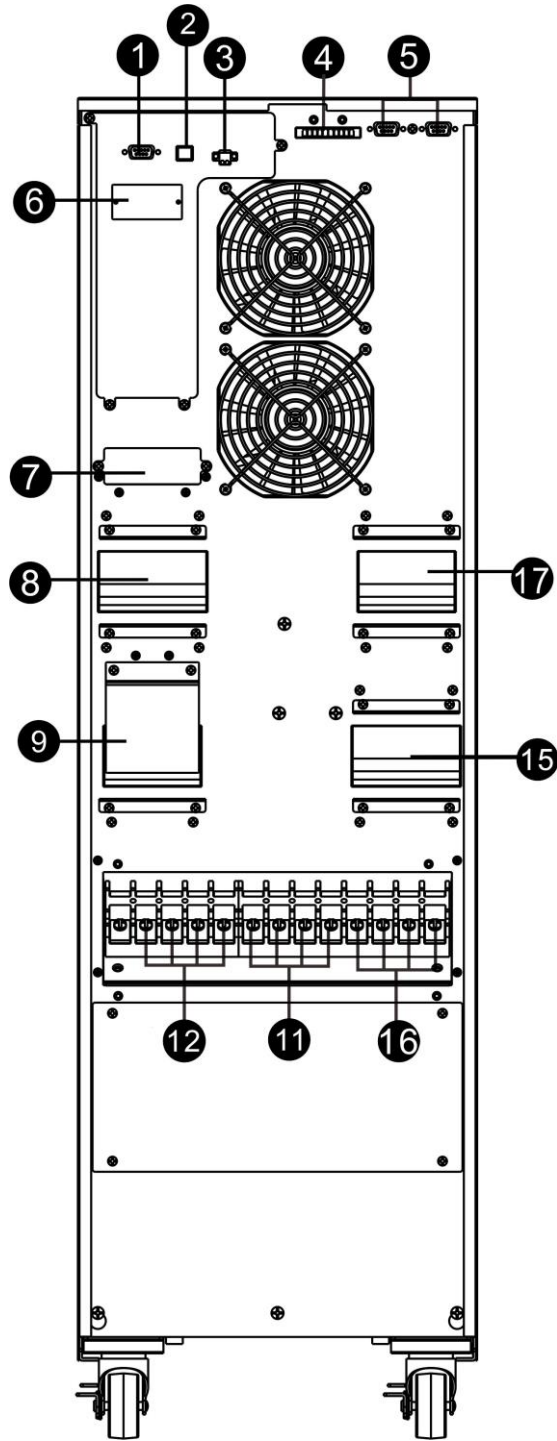

Diagram 1: HV 30K/LV 15K rear panel

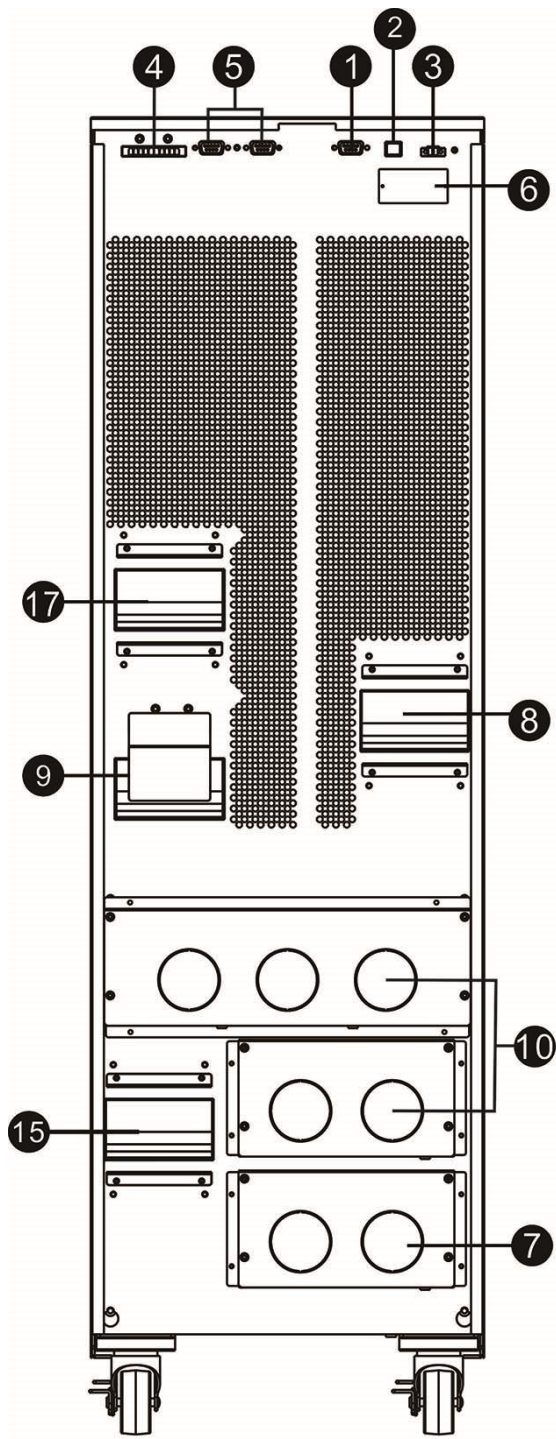

Diagram 2: HV 60KL/LV 30KL rear panel

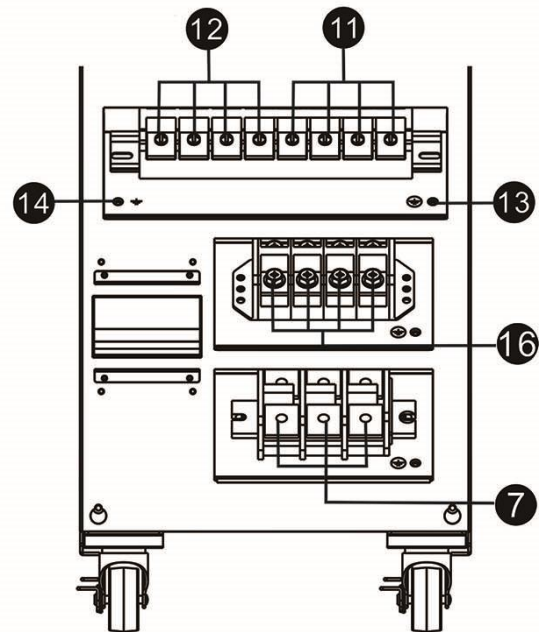

Diagram 3: HV 60KL/LV 30KL input/output terminal

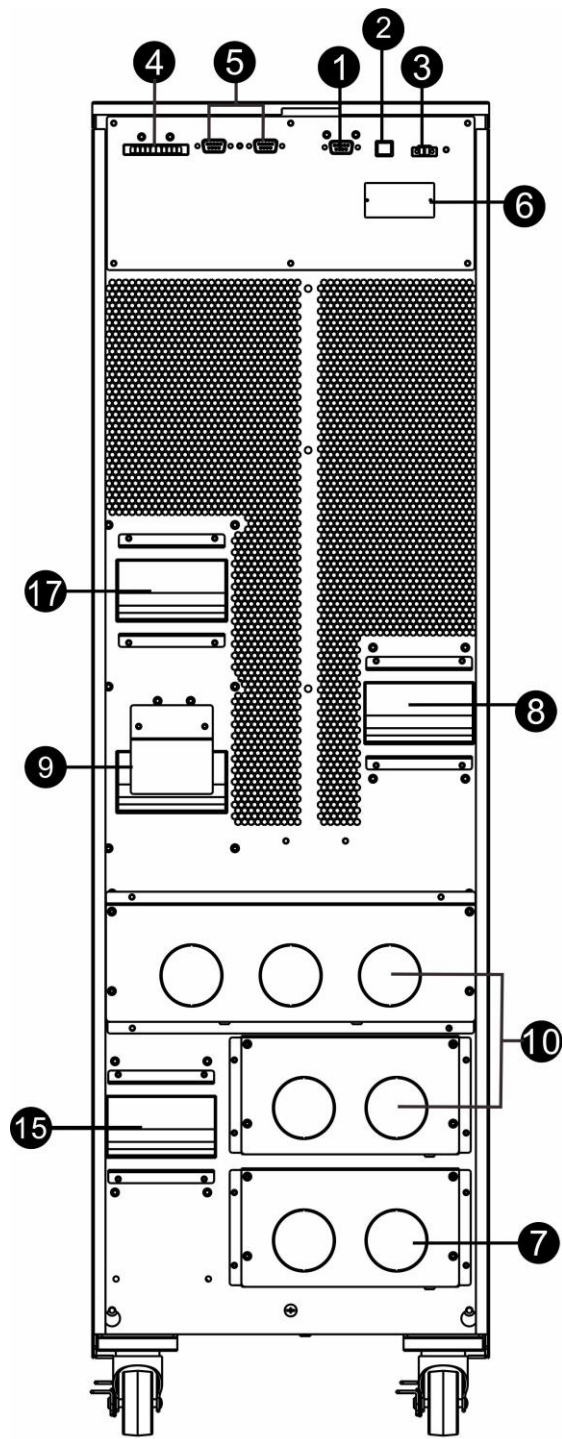

Diagram 4: HV 60KL/LV 30KL advanced rear panel

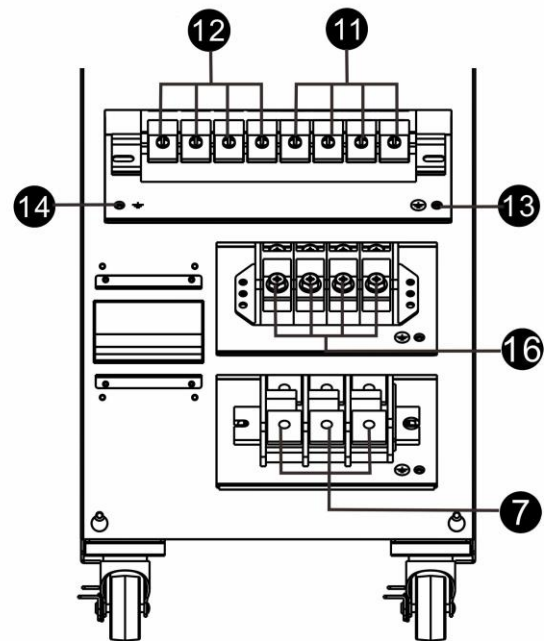

Diagram 5: HV 60KL/LV 30KL advanced input/output terminal

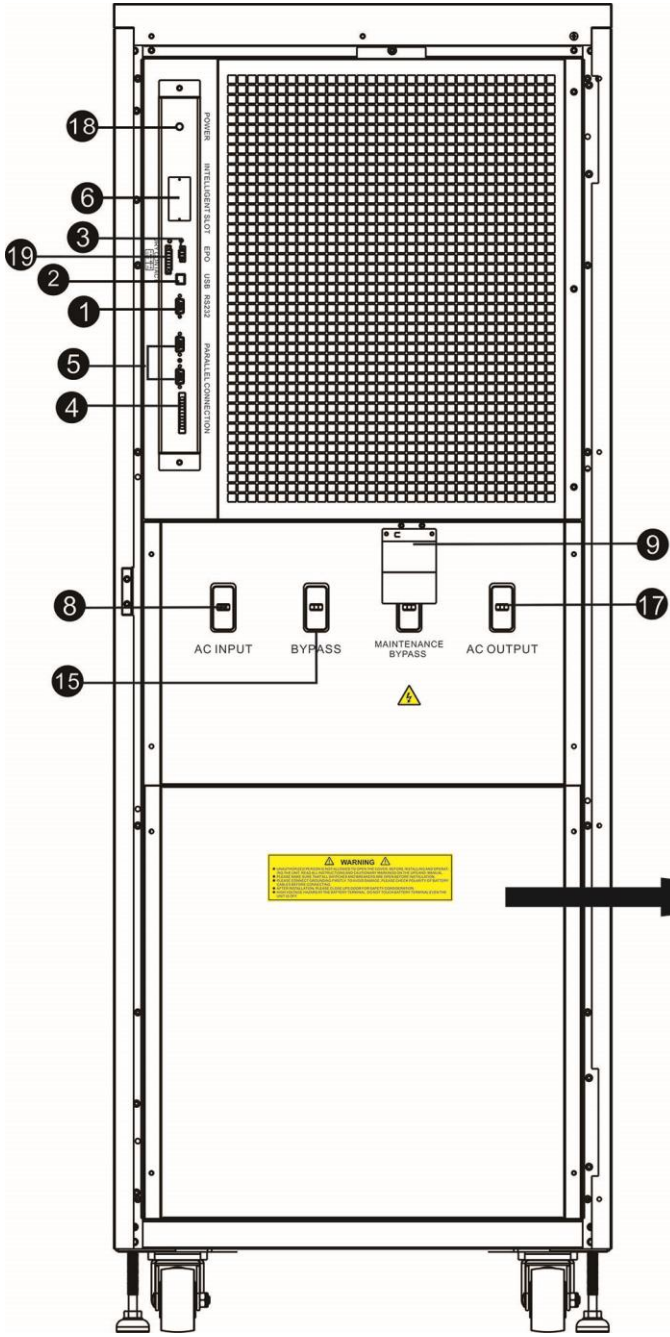

Diagram 6: HV 100KL /HV 120KL/LV 50KL/LV 60KL front door open view

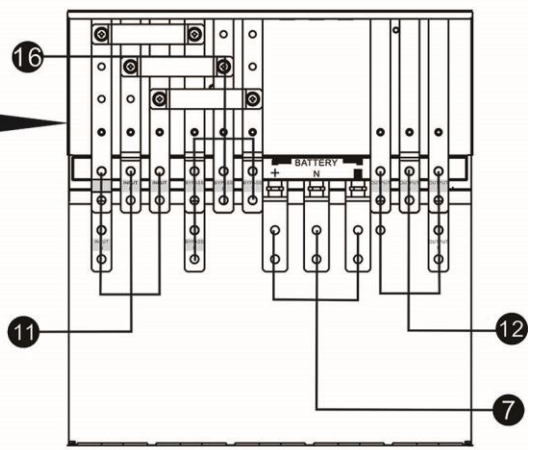

Diagram 7: HV 100KL/HV 120KL/ LV 50KL/LV 60KL terminal view

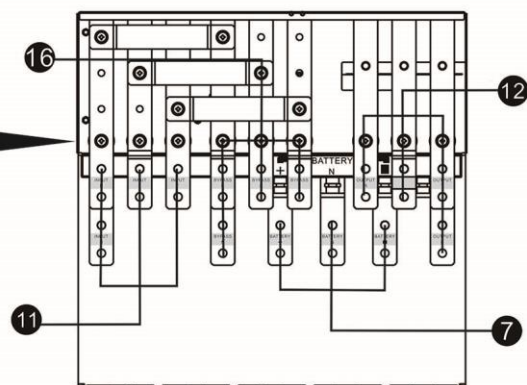
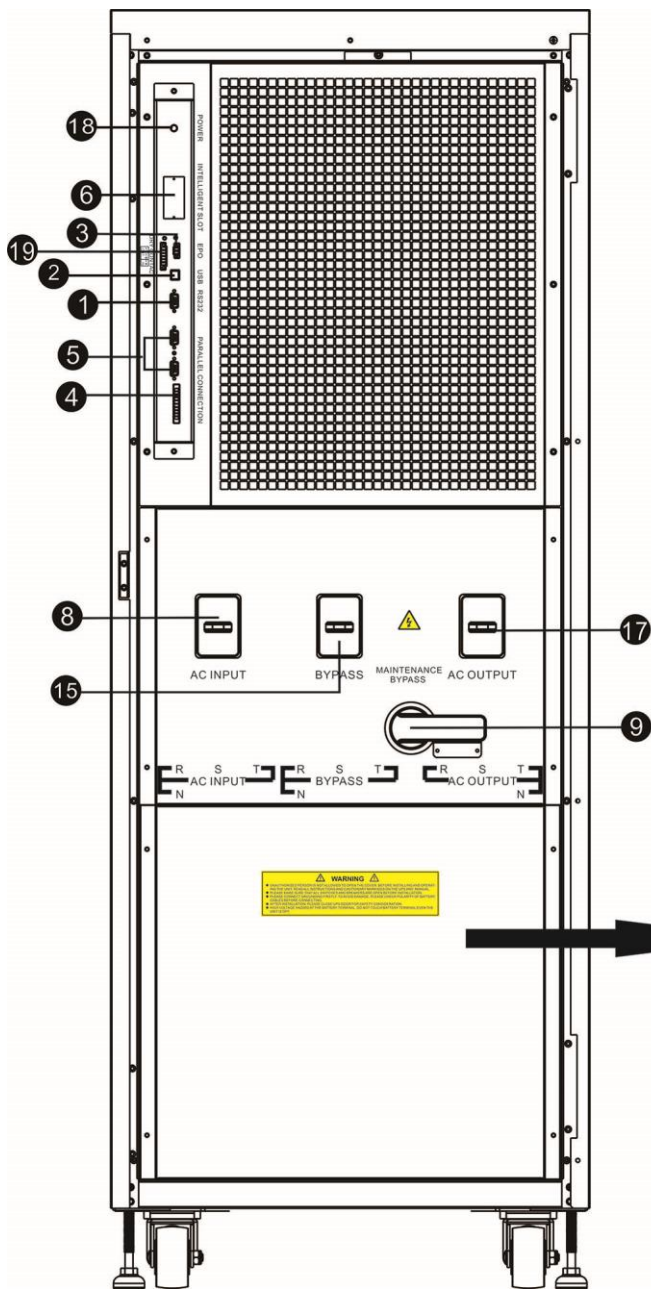

Diagram 8: HV 180KL /HV 200KL/LV 90KL/LV 100KL front door open view

Diagram 9: HV 180KL /HV 200KL/LV 90KL/LV 100KL terminal view

1. RS-232 communication port
2. USB communication port
3. Emergency power off function connector (EPO connector)
4. Share current port
5. Parallel port
6. Intelligent slot
7. External battery connector/terminal
8. Line input circuit breaker/switch
9. Maintenance bypass switch
10. Input/Output terminal (Refer to diagram 3, 5, 7 and 9 for the details)
11. Line input terminal

- 12. Output terminal
- 13. Input grounding terminal
- 14. Output grounding terminal
- 15. Bypass input circuit breaker/switch
- 16. Bypass input terminal
- 17. Output switch
- 18. Cold start function button
- 19. Dry contact communication port

2-3. UPS Positioning

The UPS should be installed in the environment with free ventilation, less dust, optimum ambient temperature and humidity.

The recommended ambient temperature is 20°C~25°C with 50% humidity.

- Ambient temperature: 0°C~+40°C
- Storage temperature: -15°C ~ 60°C
- Relative humidity: 0 ~ 95%
- Altitude: If the UPS is installed within 1000m, the UPS power will not be derated. When the height is over 1000m, the output power will be derated by following the table.

Altitude(m)	1000	1500	2000	2500	3000	3500	4000	4500	5000
Coefficient	100%	95%	91%	86%	82%	78%	74%	70%	67%

- Vertical: No vibration and the degree of deviation from vertical shouldn't be more than 5°.
- Space: It's requested to have a clearance of approx. 50 cm to the front and back of the unit and approx. 50 cm to the side.

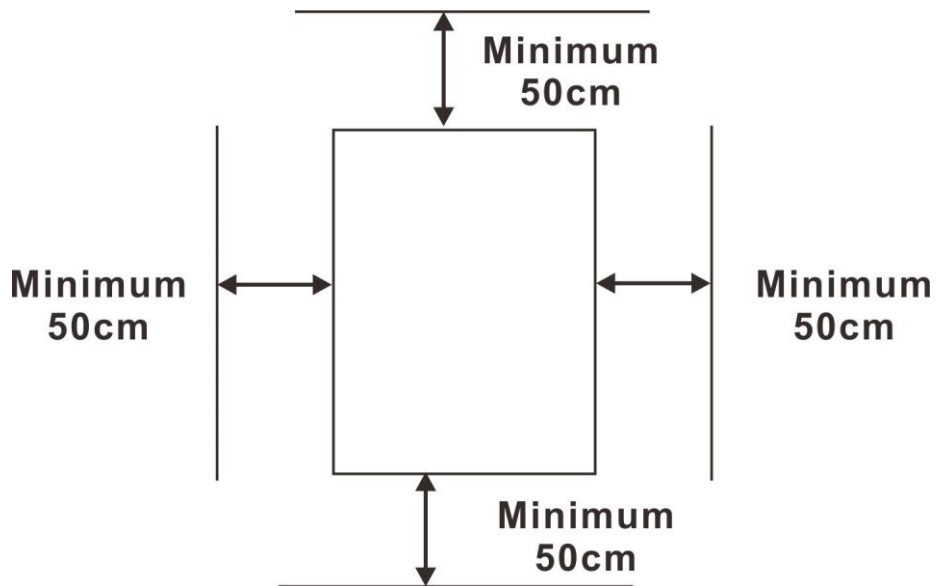

Caution! It's NOT allow to have flammable, explosive or corrosive gas or liquid in installation environment. It is forbidden to install in a metal conductive dust environment.

2-4. Single UPS Installation

Installation and wiring must be carried out in accordance with the local electric laws and regulations by trained professionals.

1) Make sure that the mains wire and breakers of the building are rated for the capacity of the UPS to prevent electric shock or risk of fire.

NOTE: Do not use the wall receptacle as the input power source for the UPS, as its rated current is less than the UPS's maximum input current. The receptacle may be damaged and destroyed.

2) Switch off the mains switch in the building before installation.

3) Turn off all the connected devices before connecting to the UPS.

4) Prepare wires based on the following table:

Model	Wiring spec (AWG)				
	Input(Ph)	Output(Ph)	Neutral	Battery	Ground
HV30KL LV15KL	8	8	4	4	4
HV30K LV15K	8	8	4		4
HV60KL LV30KL	4	4	1	1	1
HV100KL LV50KL	1	1	2/0	2/0	2/0
HV120KL LV60KL	1/0	1/0	3/0	3/0	3/0
HV180KL LV90KL	3/0	3/0	3/0*2pcs	3/0*2pcs	3/0*2pcs
HV200KL LV100KL	1*2pcs	1*2pcs	3/0*2pcs	3/0*2pcs	3/0*2pcs

NOTE 1: The cable for HV30KL/HV30K/LV15KL/LV15K should be able to withstand over 60A current. It is recommended to use AWG 8 or thicker wire for Phase and AWG 4 or thicker wire for Neutral for safety and efficiency.

NOTE 2: The cable for HV 60KL/LV 30KL should be able to withstand over 107A current. It is recommended to use AWG 4 or thicker wire for Phase and AWG 1 or thicker wire for Neutral for safety and efficiency.

NOTE 3: The cable for HV 100KL/LV 50KL should be able to withstand over 184A current. It is recommended to use AWG 1 or thicker wire for Phase and AWG 1 or thicker wire for Neutral for safety and efficiency.

NOTE 4: The cable for HV 120KL/LV 60KL should be able to withstand over 211A current. It is recommended to use AWG 1/0 or thicker wire for Phase and AWG 3/0 or thicker wire for Neutral for safety and efficiency.

NOTE 5: The cable for HV 180KL/LV 90KL should be able to withstand over 324A current. It is recommended to use AWG 3/0 or thicker wire for Phase and AWG 3/0*2pcs or thicker wire for Neutral for safety and efficiency.

NOTE 6: The cable for HV 200KL/LV 100KL should be able to withstand over 357A current. It is recommended to use AWG 1*2pcs or thicker wire for Phase and AWG 3/0*2pcs or thicker wire for Neutral for safety and efficiency.

5) Remove the terminal block cover at the rear panel of UPS. Then connect the wires according to the following terminal block diagrams: (Connect the grounding/earthing wire first when making wire connections. Disconnect the earth wire after disconnect the power wire.)

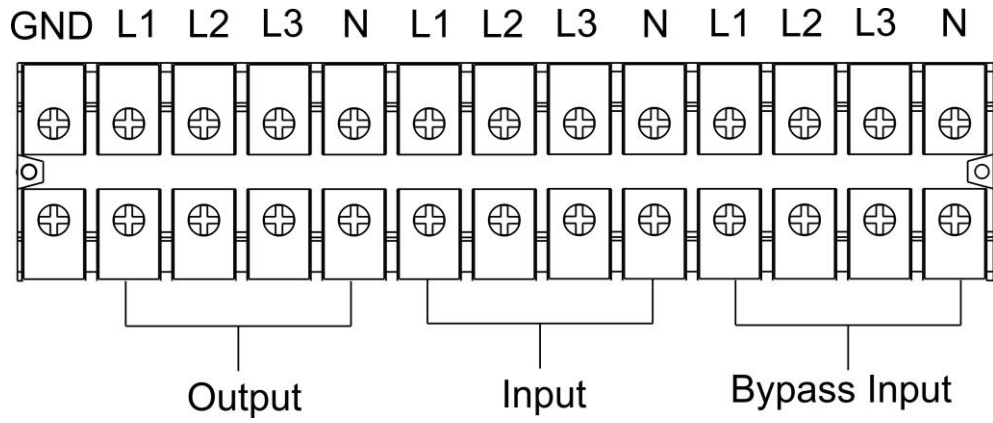

Terminal block wiring diagram for HV 30KL / LV 15KL

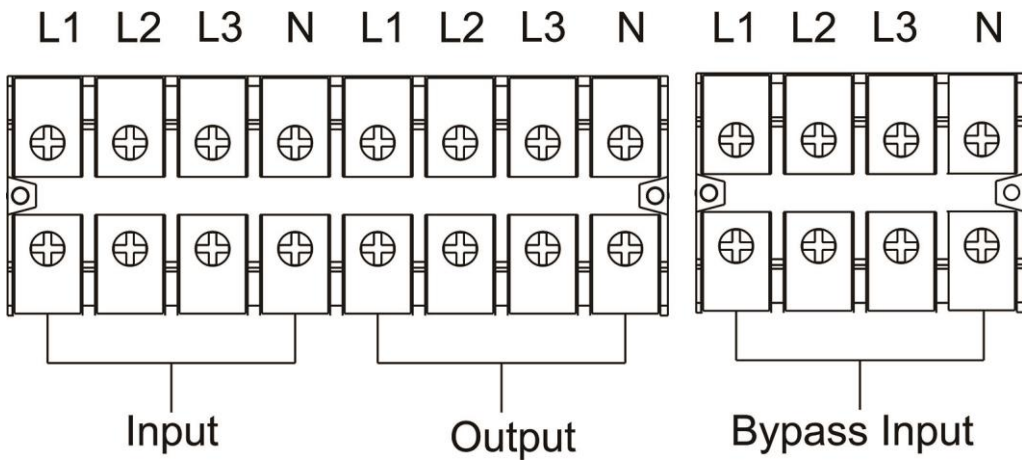

Terminal block wiring diagram for HV 60KL / LV 30KL

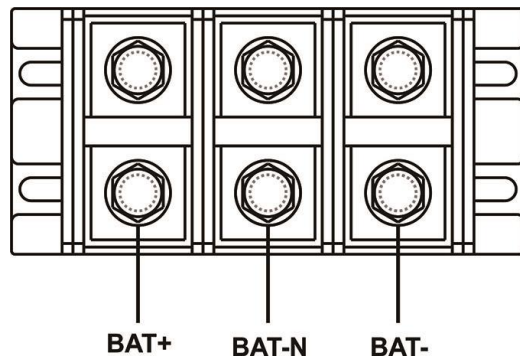

Battery terminal block wiring diagram for HV 60KL / LV 30KL

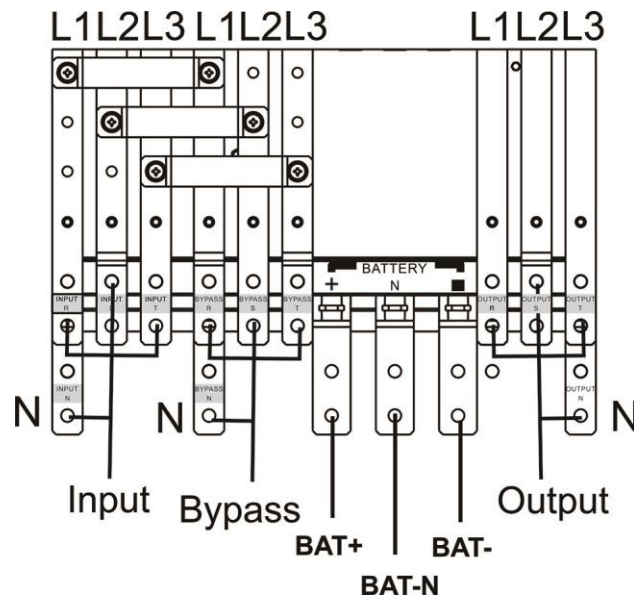

Terminal block wiring diagram for HV 100KL / 120KL / 180KL / 200KL & LV 50KL / 60KL / 90KL / 100KL

NOTE 1: Make sure that the wires are connected tightly with the terminals.

NOTE 2: Please install the output breaker between the output terminal and the load, and the breaker should be qualified with leakage current protective function if necessary.

6) Put the terminal block cover back at the rear panel of the UPS.



Warning:

- Make sure a DC breaker or other protective device between UPS and the external battery pack is installed. If not, please install it carefully. Switch off the battery breaker before installation.

NOTE: Set the battery pack breaker in "OFF" position and then install the battery pack.

- Pay highly attention to the rated battery voltage marked on the rear panel. If you want to change the numbers of the battery pack, please make sure you modify the setting simultaneously. The Connection with wrong battery voltage may cause permanent damage of the UPS. Make sure the voltage of the battery pack is correct.
- Pay highly attention to the polarity marking on external battery terminal block. And make sure the correct battery polarity is connected. Wrong connection may cause permanent damage of the UPS.
- Make sure the protective earth ground wiring is correct. The wire current spec, color, position, connection and conductance reliability should be checked carefully.
- Make sure the utility input & output wire is correct. The wire current spec, color, position, connection and conductance reliability should be checked carefully. Make sure the L/N side is correct, not reverse or short-circuited.

2-5. UPS Installation for Parallel System

If the UPS is only available for single operation, you may skip this section to the next.

- 1) Install and wires the UPS according to the section 2-3.
- 2) Connect the output wires of each UPS to an output breaker.
- 3) Connect all output breakers to a major output breaker. Then this major output breaker will directly connect to the loads.
- 4) Common battery packs or independent battery packs are allowed.
- 5) Refer to the following wiring diagram:

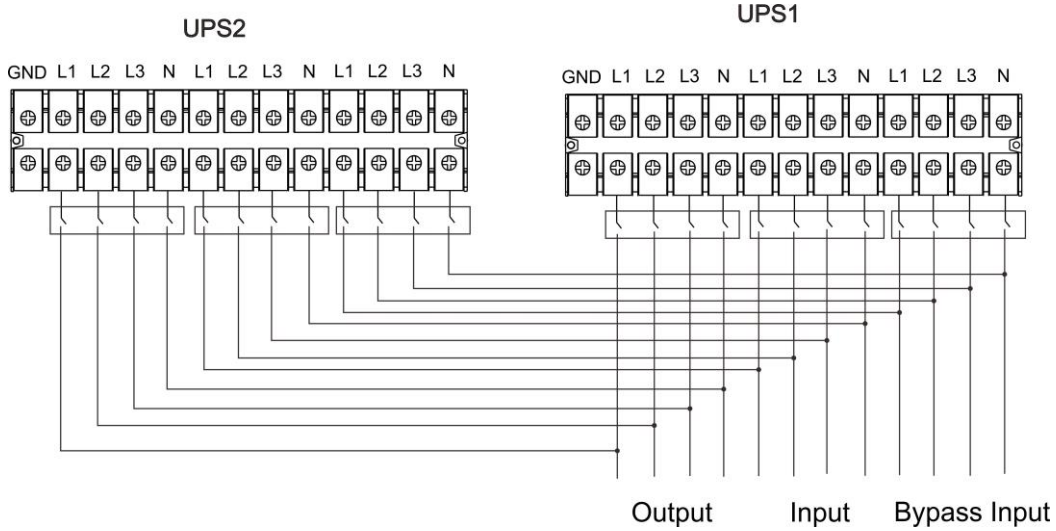

Wiring diagram of parallel system for HV30KL/LV15KL

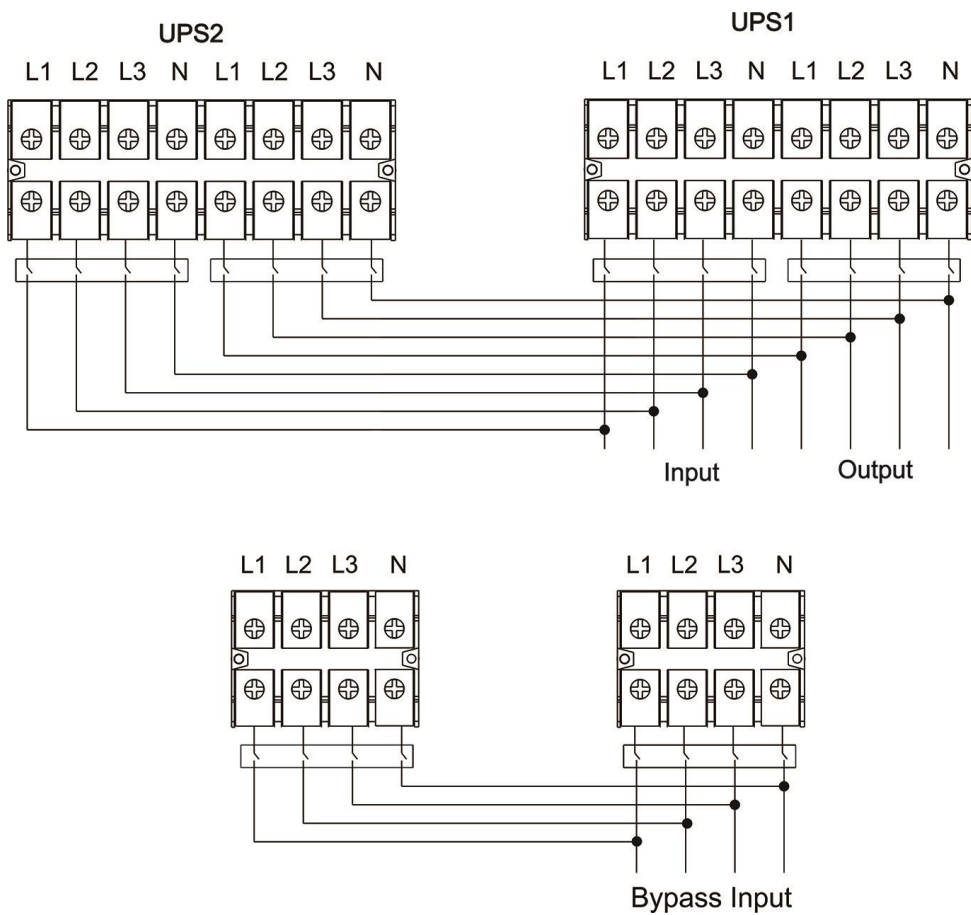

Wiring diagram of parallel system for HV 60KL/LV 30KL

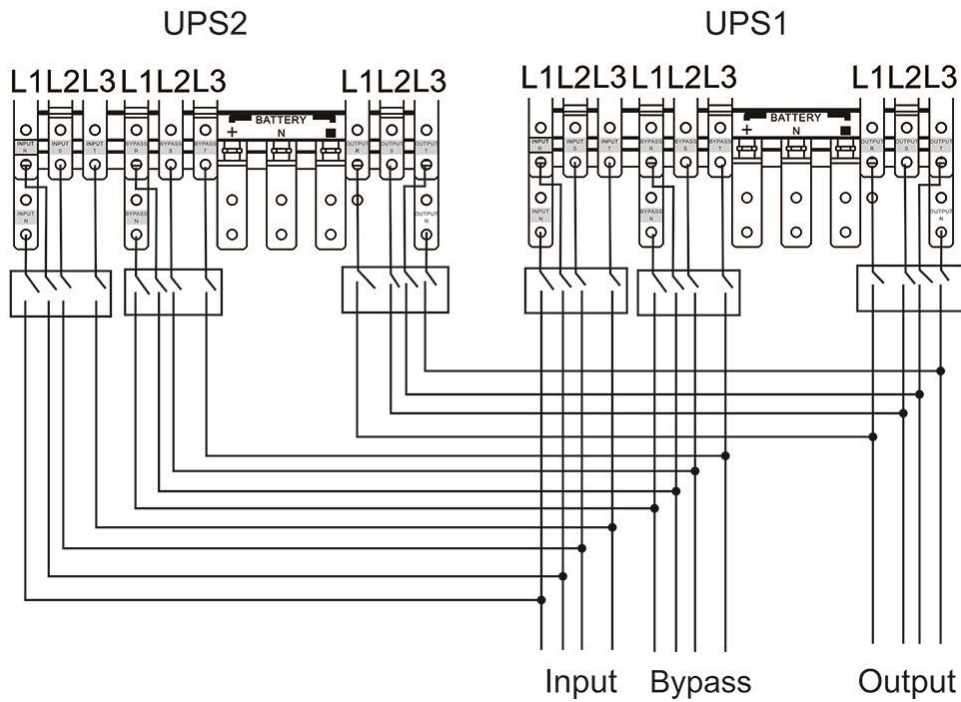

Wiring diagram of parallel system for HV 100KL / 120KL/ 180KL/ 200KL & LV 50KL / 60KL / 90KL / 100KL

2-6. Software Installation

For optimal computer system protection, install UPS monitoring software to configure UPS shutdown operation.

3. Operations

3-1. Initial Operation

- 1) Before operation, make sure that the two strings of batteries are connected correctly in order of "+,GND,-" terminals and the breaker of the battery pack is at "ON" position (only for long-run model).
- 2) Press the "POWER" button to set up the power supply for the UPS. UPS will enter to power on mode. After initialization, UPS will enter to "No Output mode".

3-2. Screen description

After initialization, the LCD will display main screen. There are five sub-menus: Control, measure, setting, information and data log. Touch any sub-menu icon to enter into the sub-screen.

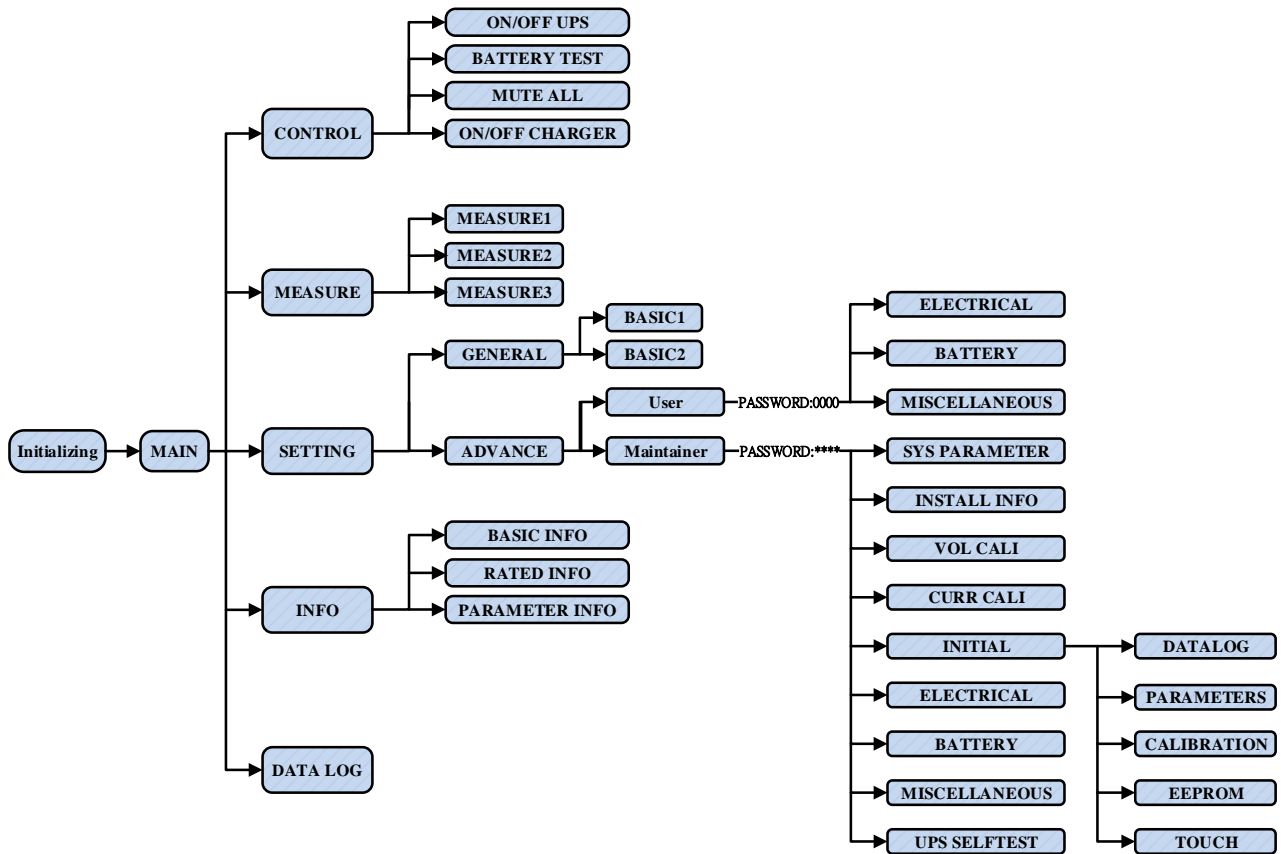

Menu tree

3-2-1 Main screen

Upon powering on, the LCD will start initialization approximately few seconds as shown below.

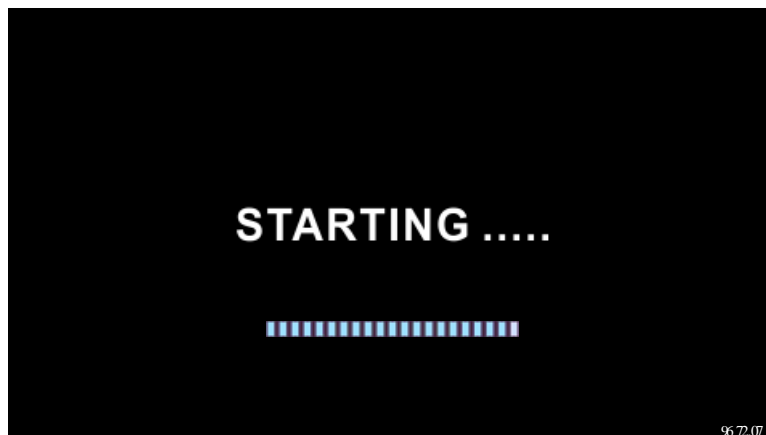

After initialization, the main screen will display as shown below. On the bottom, there are five icons to represent five sub-menus: CONTROL, MEASURE, SETTING, INFO, DATALOG.

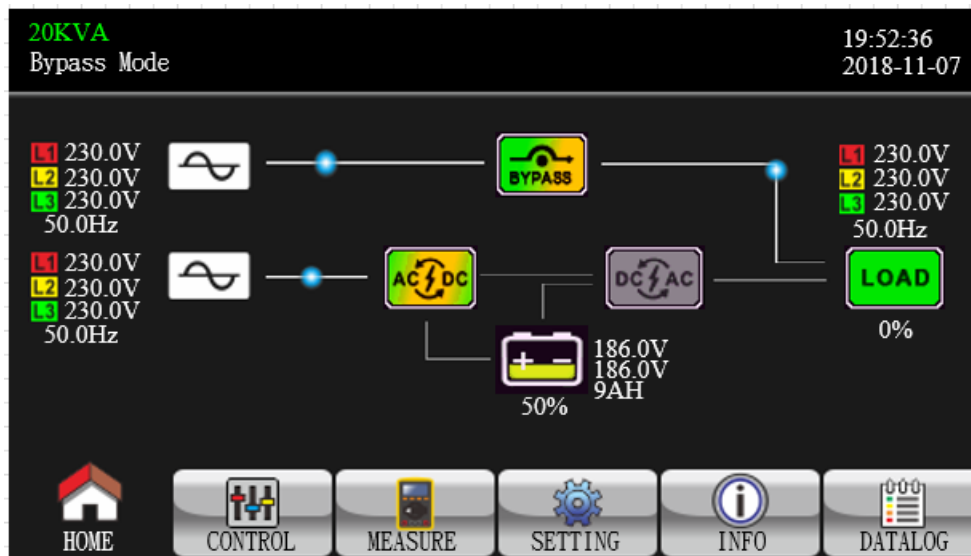

3-2-2 Control screen

Touch the icon  to enter control sub-menu.

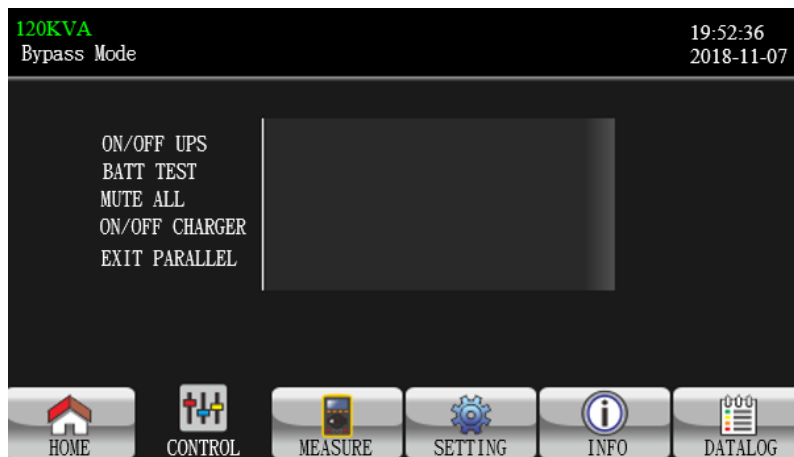

Touch  icon to return back to main screen no matter it's in any screen of any submenu.

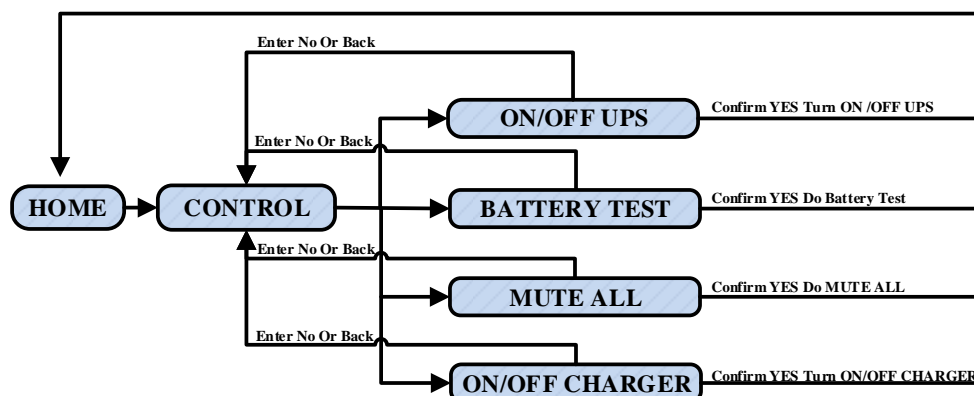

Screen 1.0 «Control» and its sub-menus

➤ On/off UPS

It will show "Turn on UPS?" when UPS is off.

It will show "Turn off UPS?" when UPS is on.

Touch "YES" to turn on or off the UPS. Then, the screen will return to main screen

Touch "Back" to return to main screen immediately or "No" to cancel this operation and back to main

screen.



TURN ON UPS

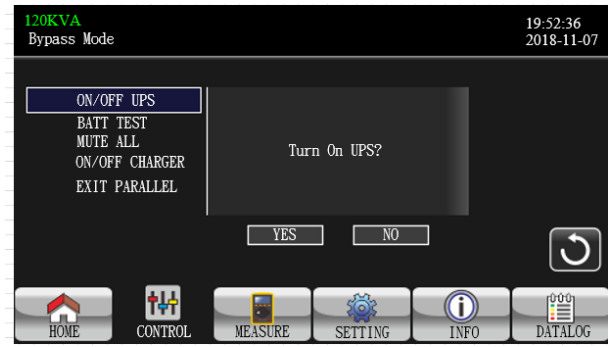

TURN OFF UPS

➤ **Battery Test**

It will show "Battery Test" if the UPS is not in test. Touch "Yes" to start battery test. Then, it will show "Battery testing...." during battery test period. After few seconds, battery test result will show on the screen. Touch "Back" to return to main screen immediately or "No" to cancel this operation and back to main screen. It will show "Cancel battery test" if the UPS is in test.



Battery Test

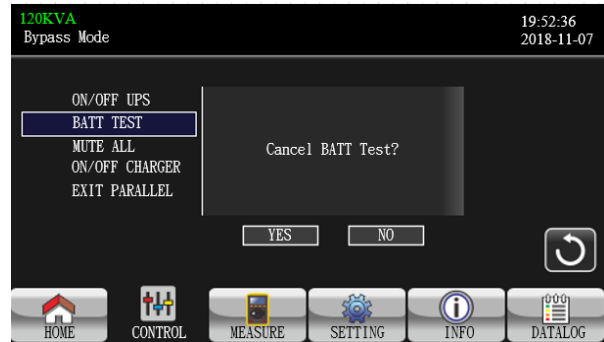

Cancel Battery Test

➤ **Audio mute**

It will show "Mute all" if the audio is active. Touch "Yes" to activate mute. If "Mute all" is active, it will show  icon on the top left corner of the main screen. Touch "Back" to return to CONTROL screen immediately or "No" to cancel this operation and back to CONTROL screen.

It will show "Cancel mute" if the UPS is mute already. Touch "Yes" activate audio function or "No" to keep mute. Touch "Back" to return to CONTROL screen.

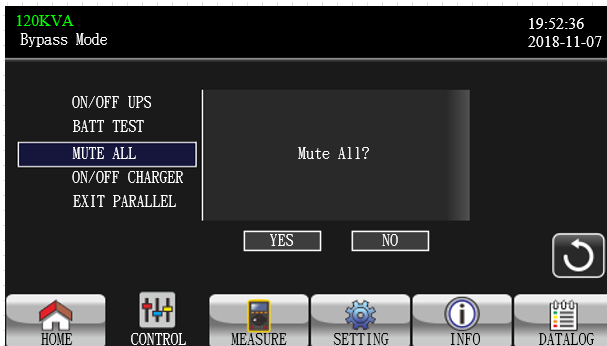

Mute All

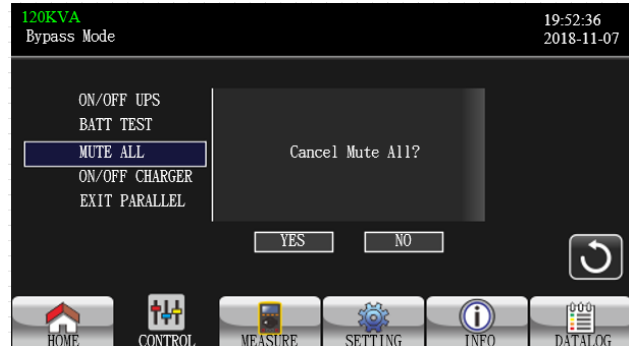

Cancel Mute all

➤ **On/Off Charger**

It will show "Turn on Charger?" when charger is off.

It will show "Turn off Charger?" when charger is on.

Touch "YES" to turn on or off the charger. Then, the screen will return to main screen.

Touch "Back" to return to CONTROL screen immediately or "No" to cancel this operation and back to CONTROL screen.

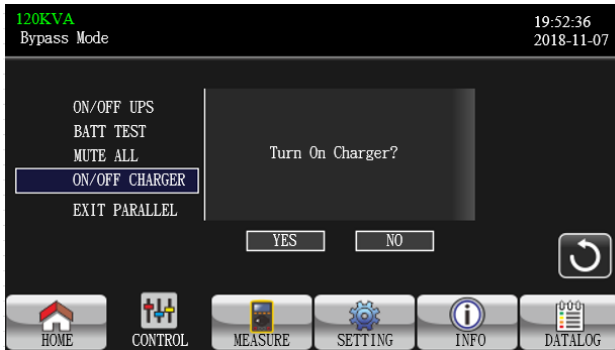

TURN ON CHARGER



TURN OFF CHARGER

➤ **EXIT PARALLEL**

In the case of multiple machines in parallel, clicking this option will pop up the "Exit and?" interface;

Click "Yes" to exit the machine from the current parallel system;

Click "No" to cancel this operation and return to the operation interface.

In the case of a single machine, clicking this option will pop up the "This setting cannot be made in this mode" interface.

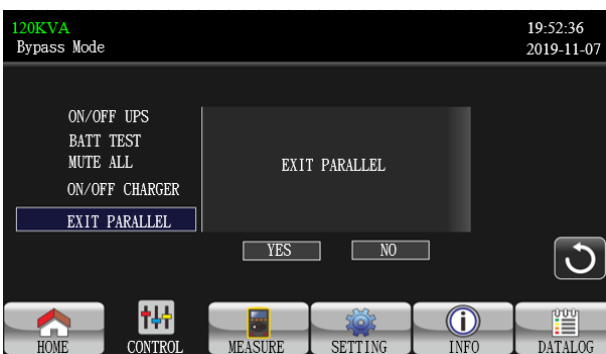



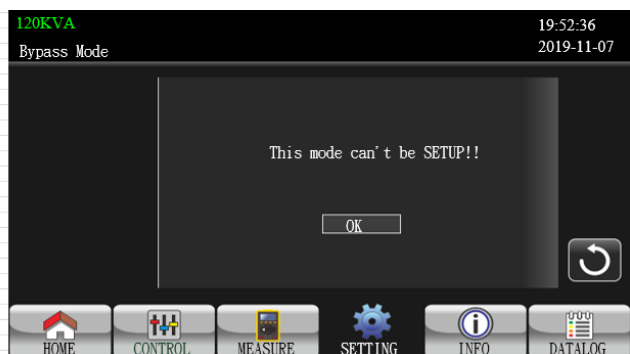

EXIT PARALLEL?



This setting cannot be made in this mode!

3-2-3 Measure screen

Touch the icon  to enter measure page. Touch the icon  or  to browse information.

Touch the icon  to return to main screen. Touch the icon  to go back to previous menu.



Measure screen page 1

- **LINE VOL:** The real time value of L1, L2 and L3 phase voltage, L12/L23/L13 voltage and input frequency.
- **INVERTER VOL:** The real time value of L1, L2 and L3 inverter voltage, L12/L23/L13 voltage and frequency.
- **BYPASS VOL:** The real time value of L1, L2 and L3 bypass voltage, L12/L23/L13 voltage and frequency.
- **OUTPUT VOL:** The real time value of L1, L2 and L3 output voltage, L12/L23/L13 voltage and frequency.

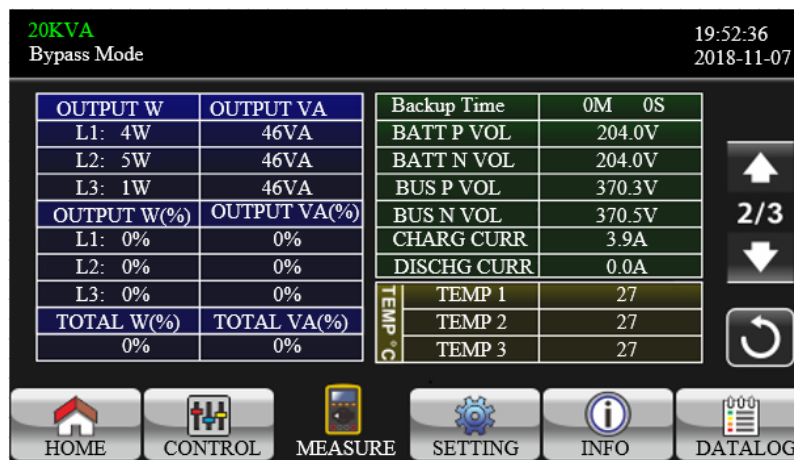

Measure screen page 2

- **OUTPUT W:** The real time value of L1, L2 and L3 output power in watt.
- **OUTPUT VA:** The real time value of L1, L2 and L3 output power in VA.
- **OUTPUT W (%):** The real time value of L1, L2 and L3 output power watt in percentage.
- **OUTPUT VA (%):** The real time value of L1, L2 and L3 output power VA in percentage.
- **Total W(%)/Total VA(%):** Total output load watt and VA in percentage.
- **Backup Time:** Display battery backup time (Min & sec).
- **BATT Voltage/Bus Voltage/Charging Current/Discharging Current:** The real time value of DC related information.
- **Temperature:** Temperature of L1, L2 and L3 phase.



20KVA		19:52:36	
Bypass Mode		2018-11-07	
INPUT W	INPUT VA	INPUT CURR	INPUT PF
L1: 4W	46VA	L1: 0.3A	0.08
L2: 4W	46VA	L2: 0.3A	0.08
L3: 4W	46VA	L3: 0.3A	0.08
INPUT W(%)	INPUT VA(%)	OUTPUT CURR	OUTPUT PF
L1: 0%	0%	L1: 0.3A	0.08
L2: 0%	0%	L2: 0.3A	0.08
L3: 0%	0%	L3: 0.3A	0.08
TOTAL W(%)	TOTAL VA(%)		
0%	0%		

Measure screen page 3

- **INPUT W:** The real time value of L1, L2 and L3 input power in watt.
- **INPUT VA:** The real time value of L1, L2 and L3 input power in VA.
- **INPUT W (%):** The real time value of L1, L2 and L3 input power watt in percentage.
- **INPUT VA (%):** The real time value of L1, L2 and L3 input power VA in percentage.
- **Total W(%)/Total VA(%):** Total input load watt and VA in percentage.
- **Input current:** The real-time value of input current in L1, L2 and L3 phases.
- **Input PF:** The real-time value of input power factor in L1, L2 and L3 phases.
- **Output current:** The real-time value of output current in L1, L2 and L3 phases.
- **Output PF:** The real-time value of output power factor in L1, L2 and L3 phases.

3-2-4 Setting screen

This sub-menu is used to set the parameters of UPS. Touch the icon  to enter setting menu page.

There are 2 options: Basic and Advanced. Touch the icon  to return to main screen. Touch the icon  to go back to previous menu.

NOTE: Not all settings are available in every operation mode. If the setting is not available in present mode, the LCD will keep its original setting parameter showed instead of changing the parameters.

120KVA		19:52:36	
Bypass Mode		2018-11-07	
GENERAL			
ADVANCE			

Setting screen

- **GENERAL:** It's to set up basic information of the UPS. It's not related to any function parameter.
- **ADVANCE:** It's required to enter password to access to the "ADVANCE" setting. There are two types of authority, User and Maintainer.

GENERAL





General screen page 1

- **Language:** Set the LCD language. There are three languages available, English, Simplified Chinese and Traditional Chinese.
- **Input Source:** Select the input source. There are two options: Line (utility) and generator. Line is default setting. This setting value will show on the main page. When “generator” is selected, the acceptable input frequency will be fixed at the range of 40~70Hz. This setting value will show on the status bar.
- **Contact:** Set the name of contact person and the maximum length is 18 characters.
- **Phone:** Set the service phone number. Only 0~9, + and – are accepted. The maximum length is 14 characters.
- **Mail:** Set the service email accounts up to two and the maximum length is 36 characters.



General screen page 2

- **Audio Alarm:** There are two events available to mute. You may choose “Enable” or “Disable” alarm when related events occur.
 - Enable: When selected, alarm will be mute when related events occur.
 - Disable: When selected, UPS will alarm when related events occur.
- All Mute: When “enable” is selected, all the faults and warnings will be mute. It will show  icon on the top right corner of the main screen.
- Mode Mute: UPS status mode alarm enable/disable. If “Mode Mute” is activated, it will show  icon

icon on the top right corner of the main screen.

ADVANCE



Advance Password Page

It's required to enter password to access to the "ADVANCE" page. There are two levels of password protection: user and maintainer. Entering different level of authority can access to different settings.

- **ADVANCE → User**

To access to the "Advance→User" Setting menu page, the default password is "0000".

If entered password is right, the page will jump to setting screen. If the password is wrong, it will ask to enter again.

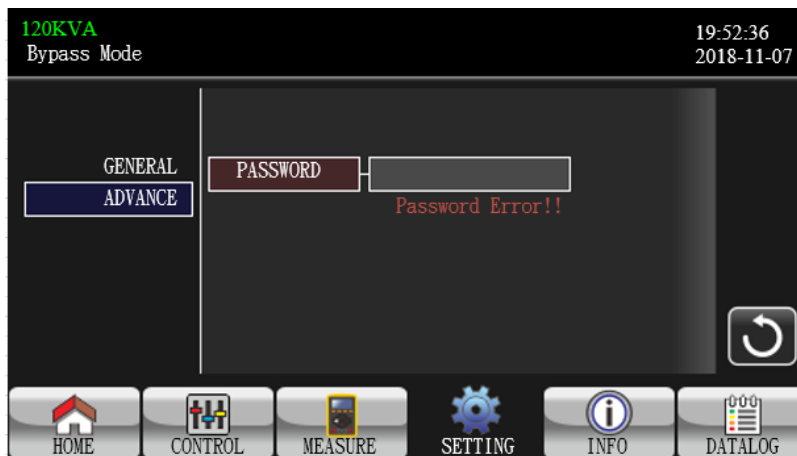

Password Error Page

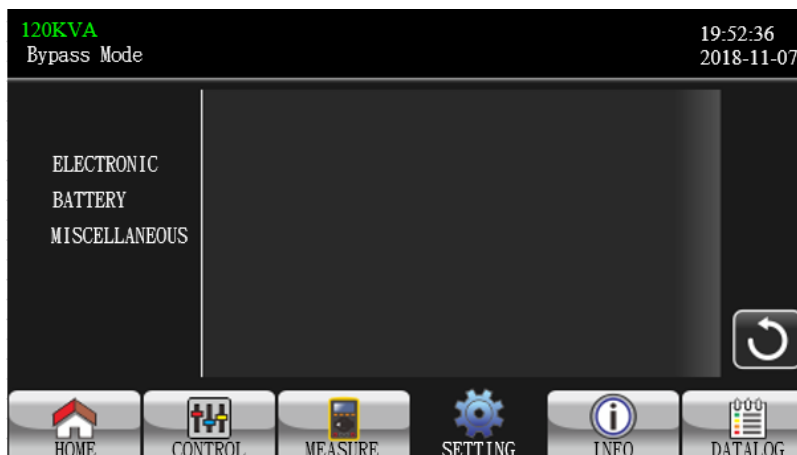

Advance Setting Menu Page

There are three sub-menus under "Advance→User" setting: ELECTRONIC, BATTERY and MISCELLANEOUS.

ELECTRONIC



Electronic Setting Page 1

- **OUTPUT VOL:** Select the output rated voltage.
 - When UPS is HV system, there are four options, 208V, 220V, 230V and 240V.
 - When UPS is LV system, there are two options, 120V and 127V.
- **OUTPUT FRE:** Select output rated frequency.
 - **50Hz:** The output frequency is setting for 50Hz.
 - **60Hz:** The output frequency is setting for 60Hz.
- **CVCF Mode** (constant voltage and constant frequency function)
 - **Enable:** CVCF function is enabled. The output frequency will be fixed at 50Hz or 60Hz according to setting of "OP Freq.". The input frequency could be from 46Hz to 64Hz.
 - **Disable:** CVCF function is disabled. The output frequency will synchronize with the bypass frequency within 46~54 Hz for 50Hz system or within 56~64 Hz for 60Hz system. Disable is the default setting.
- **Bypass Forbid:**
 - **Enable:** Bypass forbid is enabled. When selected, it's not allowed for running in Bypass mode under any situations.
 - **Disable:** Bypass forbid is disabled. When selected, UPS will run in Bypass mode depending on "Bypass at UPS off" setting. It is the default setting.
- **Neutral Line Check:**
 - **Disable:** Disable the neutral line check function. The UPS will not detect if the neutral line is loss or not.
 - **Auto:** The UPS will automatically detect if the neutral is lost or not. If neutral loss is detected, an alarm will be generated. If the UPS is turned on, it will transfer to battery mode. When neutral line is restored and detected, the alarm will be muted automatically and the UPS will go back to normal mode automatically.
 - **Check:** The UPS will automatically detect the neutral loss. If neutral loss is detected, an alarm will be generated. If the UPS is turned on, it will transfer to battery mode. When neutral is restored, the alarm will NOT be muted automatically and the UPS will NOT go back to normal mode automatically.
- **ISO Compensation:**

When UPS is connected to output isolation, it will compensate the output voltage.



Electronic Setting Page 2

- **Bypass UPS off:** Select the bypass status when manually turning off the UPS. This setting is only available when "Bypass forbid." is set to "Disable".
 - **Enable:** Bypass enabled. When selected, bypass mode is activated.
 - **Disable:** Bypass disabled. When selected, no output through bypass when manually turning off the UPS. To protect power continuity on output load, when UPS fault or UPS transfers to bypass due to overload on AC mode, the UPS will force to turn on bypass output by default.
- **Bypass VOL Range:** Set the bypass voltage range.
 - **L:** Low voltage point for bypass. The setting range is 176V ~ 209V when UPS is HV system. The setting range is 96V ~ 110V when UPS is LV system.
 - **H:** High voltage point for bypass. The setting range is 231V ~ 264V when UPS is HV system. The setting range is 130V ~ 146V when UPS is LV system.
- **Bypass FRE Range:** Set the bypass frequency range.
The acceptable bypass frequency range from 46Hz to 54Hz when UPS is 50Hz system and from 56Hz to 64Hz when UPS is 60Hz system.
- **ECO mode:** Enable/Disable ECO mode. Default setting is "Disable".
- **ECO VOL Range:** Set the ECO voltage range.
 - **L:** Low voltage point for ECO mode. The setting range is from "Rated output voltage - 5V" to "Rated output voltage - 11V". "Rated output voltage - 5V" is default setting.
 - **H:** High voltage point for ECO mode. The setting range is from "Rated output voltage + 5V" to "Rated output voltage + 11V". "Rated output voltage + 5V" is default setting.
- **ECO FRE Range:** Set the ECO frequency range. The setting range is from 46Hz to 54Hz when the UPS is 50Hz system and from 56Hz to 64Hz when the UPS is 60Hz system.

BATTERY



Battery setting page

- **BATT Warning VOL:** Set battery warning voltage.
 - **HIGH:** High battery warning voltage. The setting range is 14.0V ~ 15.0V. 14.4V is default setting.
 - **LOW:** Low battery warning voltage. The setting range is 10.1V ~ 14.0V. 11.4V is default setting.

This parameter setting is related to "Shutdown Voltage" setting. This setting value should be higher than "Shutdown Voltage" setting.
- **Shutdown VOL:** If battery voltage is lower than this point in battery mode, UPS will automatically shut down. The setting range is 10.5V ~ 12.0V. 10.7V is default setting.
- **BATT Age:** Set up battery age.
- **Battery Parameters:**
 - Battery AH: setting battery capacity.

MISCELLANEOUS



Miscellaneous setting page

- **Auto Restart:**
 - **Enable:** After "Enable" is set, once UPS shutdown occurs due to low battery and then utility restores, the UPS will return to line mode.
 - **Disable:** After "Disable" is set, once UPS shutdown occurs and the utility restores, the UPS will not automatically turn on.
- **Shutdown Delay:** UPS will shut down in setting minutes. The countdown will start after confirming the pop-up screen.
- **Restore Delay:** UPS will automatically restart in setting minutes after the UPS shuts down.
- **New Password:** Set up new password to enter "ADVANCE → User" menu.
- **ADVANCE → Maintainer**

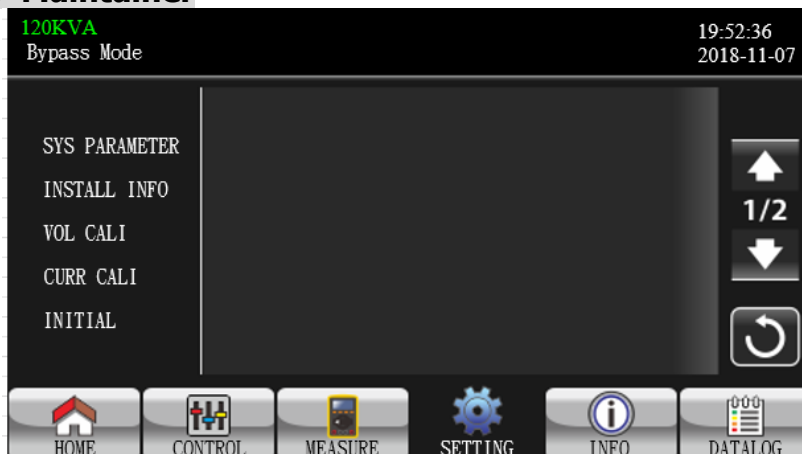

Advance → Maintainer Setting Page 1



Advance→Maintainer Setting Page 2

To access the “Advance→Maintainer” Setting menu page, it’s required to enter password. Please contact your local dealer to get maintainer password.

CAUTION: This setting menu is only for qualified technician. Otherwise, mis-operation will cause UPS damage.

There are five sub-menus under “Advance→Maintainer” setting: SYS PARAMETER, INSTALL INFO, VOL CALI, CURR CALI, INITIAL, ELECTRONIC, BATT, MISCELLANEOUS and UPS SELFTEST.

SYS PARAMETER



SYS PARAMETER Page1

- **Mode Name:** Set the UPS model name.
- **Serial Number:** Set the serial number.
- **Manufacturer:** Set the UPS manufacturer.
- **Charger Number:** The number of charging boards installed in the UPS.
NOTE: It’s required to restart the UPS after setting.
- **Max Charge CURR:** Set maximum charge current
 - One piece of charger: 1A – 18A
 - Two pieces of chargers: 2A – 36A
 - Three pieces of chargers: 3A – 54A
- **BATT Number:** The total number of installed battery. (It should be restart UPS after setting.) The setting range is 16 ~ 20. 16 is default setting.



SYS PARAMETER Page 2

- **Float VOL:** The setting point of battery float voltage. 13.6V is default setting.
- **UPS Type:** There are two options, HV and LV. This change is only allowed for qualified technician.
NOTE: It's required to restart the UPS after setting.
- **Power Setting:** Set power factor in percentage.
- **Output setting:** Set UPS output setting. There are two selections, 3-1 and 3-3.
NOTE: It's required to restart the UPS after setting.
- **Customer Code:** Set customer code.
- **DynamicPassword:** Enable or disable dynamic password function.

INSTALL INFO

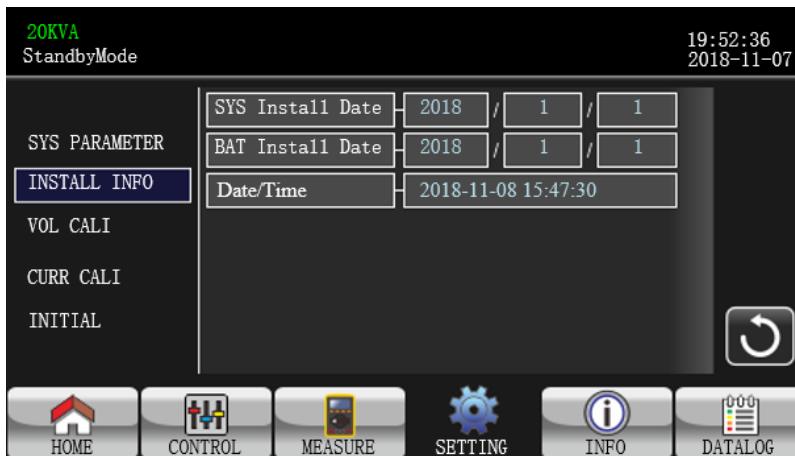



INSTALL INFO Page

- **SYS Install Date:** Set the date of UPS installation.
- **BAT Install Date:** Set the date of Battery installation.
- **Date/Time:** Set the date and time. The format is YYYY-MM-DD HH:MM:SS. The calendar day will be automatically changed when the year, month and date are set.

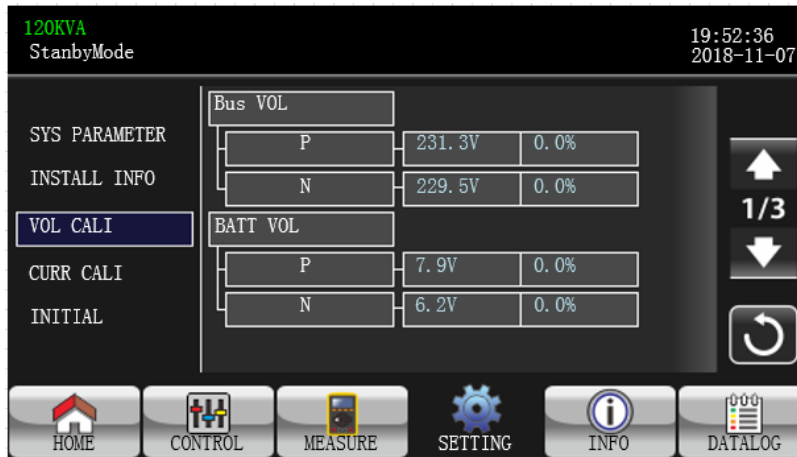
VOL CALI



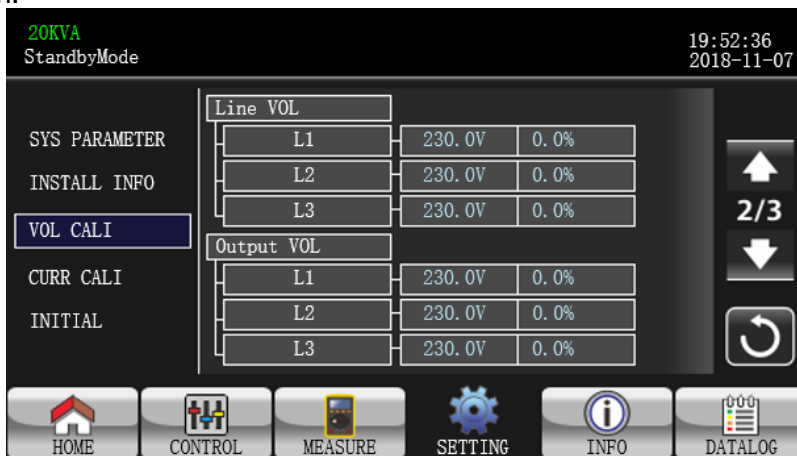

VOL CALI Page1

- **Bus VOL:** BUS voltage calibration. Each click is 0.1% no matter it's pressing up or down key . Press "up" key to increase 0.1% and press "down" key to decrease 0.1%. Press "OK" key to confirm the modification.
- **BATT VOL:** Battery voltage calibration. Each click is 0.1% no matter it's pressing up or down key . Press "up" key to increase 0.1% and press "down" key to decrease 0.1%. Press "OK" key to confirm the modification.







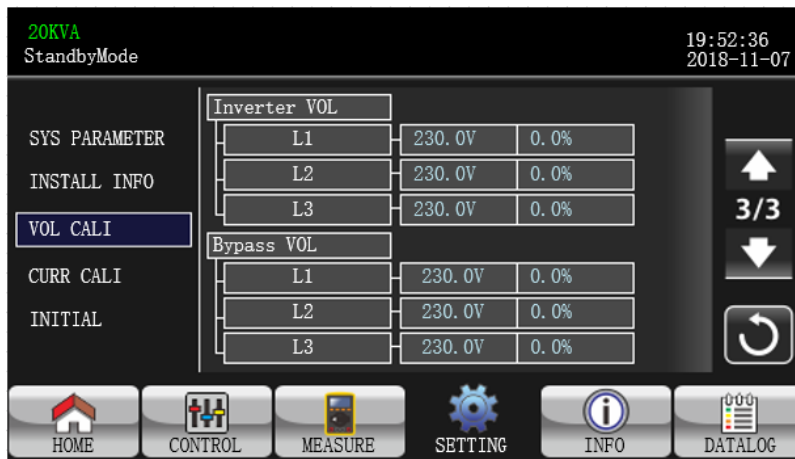

VOL CALI Page2

- **Line VOL:** Line voltage calibration. Each click is 0.1% no matter it's pressing up or down key . Press "up" key to increase 0.1% and press "down" key to decrease 0.1%. Press "OK" key to confirm the modification.
- **Output VOL:** Output voltage calibration. Each click is 0.1% no matter it's pressing up or down key . Press "up" key to increase 0.1% and press "down" key to decrease 0.1%. Press "OK" key to confirm the modification.





VOL CALI Page3

- **Inverter VOL:** Inverter voltage calibration. Each click is 0.1% no matter it's pressing up or down key   . Press "up" key to increase 0.1% and press "down" key to decrease 0.1%. Press "OK" key to confirm the modification.
- **Bypass VOL:** Bypass voltage calibration. Each click is 0.1% no matter it's pressing up or down key   . Press "up" key to increase 0.1% and press "down" key to decrease 0.1%. Press "OK" key to confirm the modification.

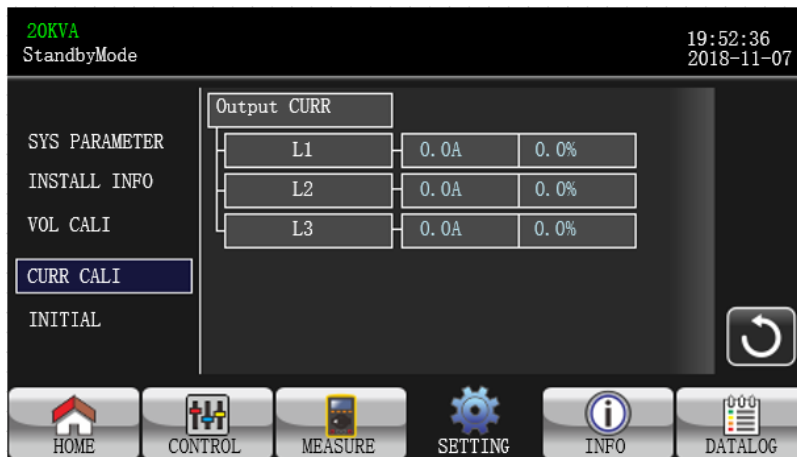
CURR CALI



CURR CALI Page

- **Output CURR:** Output current calibration. Each click is 0.1% no matter it's pressing up or down key   . Press "up" key to increase 0.1% and press "down" key to decrease 0.1%. Press "OK" key to confirm the modification.

INITIAL

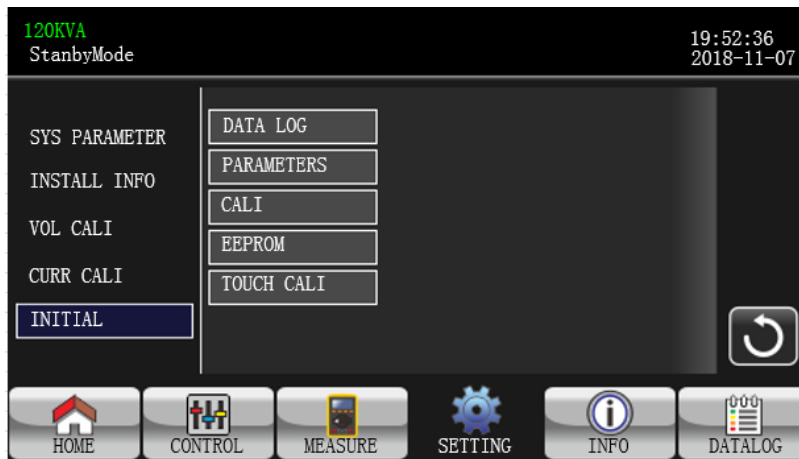

INITIAL menu Page

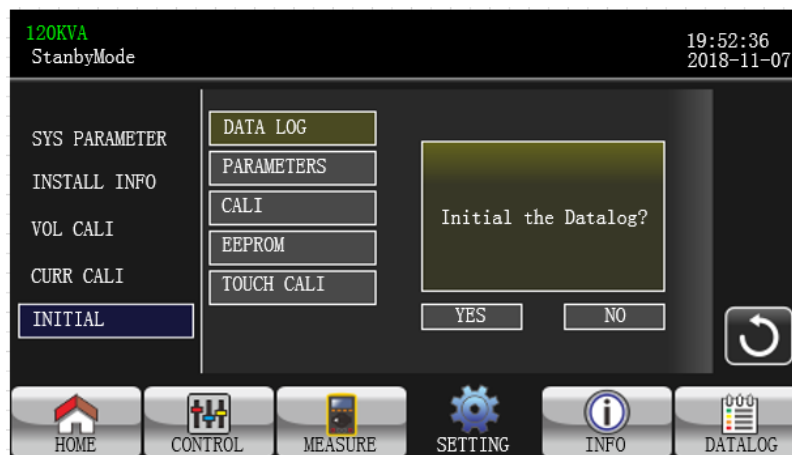

INITIAL DATALOG Page

- **DATA LOG:** After pressing, the confirmation window, it will pop up as shown in above screen. Touch "YES" to clear the DATALOG page. Touch "Back" or "No" to cancel this operation and back to INITIAL menu page.



INITIAL PARAMETERS Page

- **PARAMETERS:** After pressing the confirmation window, it will pop up as shown in above screen. Touch "YES" to restore default value. Touch "Back" or "No" to cancel this operation and back to INITIAL menu page.

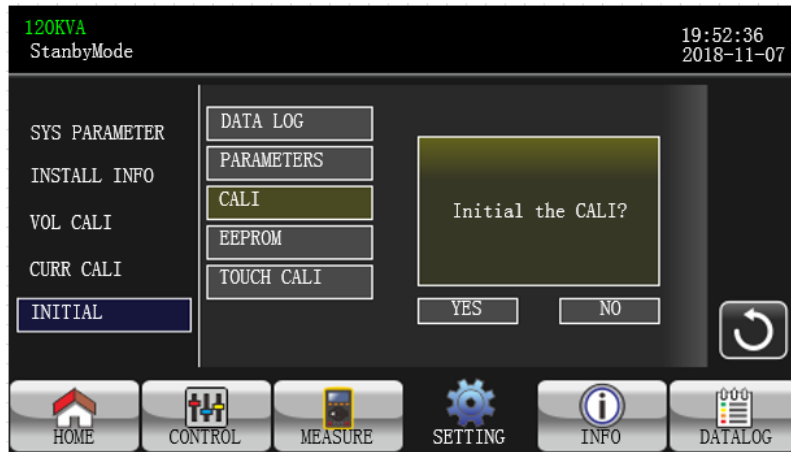

INITIAL CALI Page

- **CALI:** After pressing the confirmation window, it will pop up as shown in above screen. Touch "YES" to restore default calibration value. Touch "Back" or "No" to cancel this operation and back to INITIAL menu page.

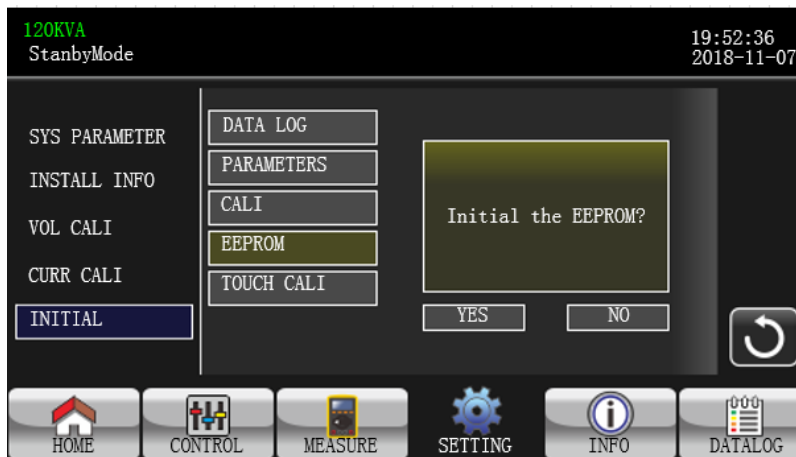

INITIAL EEPROM Page

- **EEPROM:** After pressing the confirmation window, it will pop up as shown in above screen. Touch "YES" to clear all setting value in EEPROM. Touch "Back" or "No" to cancel this operation and back to INITIAL menu page.



INITIAL TOUCH Page

- **TOUCH CALI:** After pressing the confirmation window, it will pop up as shown in above screen. Touch screen to recalibrate. Then, the blue screen appears and please click on the place of the cross with your mouse.

ELECTRONIC



Electronic Setting Page 1

- **OUTPUT VOL:** Select the output rated voltage.
 - When UPS is HV system, there are four options, 208V, 220V, 230V and 240V.
 - When UPS is LV system, there are two options, 120V and 127V.
- **OUTPUT FRE:** Select output rated frequency.
 - **50Hz:** The output frequency is setting for 50Hz.
 - **60Hz:** The output frequency is setting for 60Hz.
- **CVCF Mode** (constant voltage and constant frequency function)
 - **Enable:** CVCF function is enabled. The output frequency will be fixed at 50Hz or 60Hz according to setting of "Output Freq.". The input frequency could be from 46Hz to 64Hz.
 - **Disable:** CVCF function is disabled. The output frequency will synchronize with the bypass frequency within 46~54 Hz for 50Hz system or within 54~64 Hz for 60Hz system. Disable is the default setting.
- **Bypass Forbid:**
 - **Enable:** Bypass Forbid is enabled. It's not allowed for running in Bypass mode under any situations.
 - **Disable:** Bypass Forbid is disabled. UPS will run in Bypass mode. It is the default setting.
- **Neutral Line Check:** Check if neutral line is correctly connected or not.
 - **Disable:** Disable the neutral loss detection function. The UPS will not detect the neutral loss or not.
 - **Auto:** The UPS will automatically detect the neutral is lost or not. If neutral loss is detected, an alarm will be generated. If the UPS is turned on, it will transfer to battery mode. When neutral is restored and detected, the alarm will be muted automatically and the UPS will go back to normal mode automatically.
 - **Check:** The UPS will detect the neutral loss or not only when first commission. If neutral loss is detected, an alarm will be generated. If the UPS is turned on, it will transfer to battery mode. When neutral is restored, the alarm will NOT be muted automatically and the UPS will NOT go back to normal mode automatically. Please be sure to enter this selection and re-start the UPS again to mute alarm.
- **ISO Compensation**

When UPS is connected to output isolation, it will compensate the output voltage.



Electronic Setting Page 2

- **Bypass UPS off:** Select the bypass status when manually turning off the UPS. This setting is only available when "Bypass forbid" is set to "Disable".
 - **Enable:** Bypass enabled. When selected, bypass mode is activated.
 - **Disable:** Bypass disabled. When selected, no output through bypass when manually turning off the UPS. To protect power continuity on output load, when UPS fault or UPS transfers to bypass due to overload on AC mode, the UPS will force to turn on bypass output by default.
- **Bypass VOL Range:** Set the bypass voltage range.
 - **L:** Low voltage point for bypass. The setting range is 176V ~ 209V when UPS is HV system. The setting range is 96V ~ 110V when UPS is LV system.
 - **H:** High voltage point for bypass. The setting range is 231V ~ 264V when UPS is HV system. The setting range is 139V ~ 146V when UPS is LV system.
- **Bypass FRE Range:** Set the bypass frequency range.
The acceptable bypass frequency range from 46Hz to 54Hz when UPS is 50Hz system and from 56Hz to 64Hz when UPS is 60Hz system.
- **ECO mode:** Enable/Disable ECO mode. Default setting is "Disable".
- **ECO VOL Range:** Set the ECO voltage range.
 - **L:** Low voltage point for ECO mode. The setting range is from "Rated output voltage - 5V" to "Rated output voltage - 11V". "Rated output voltage - 5V" is default setting.
 - **H:** High voltage point for ECO mode. The setting range is from "Rated output voltage + 5V" to "Rated output voltage + 11V". "Rated output voltage + 5V" is default setting.
- **ECO FRE Range:** Set the ECO frequency range. The setting range is from 48Hz to 52Hz when the UPS is 50Hz system and from 58Hz to 62Hz when the UPS is 60Hz system.

BATTERY

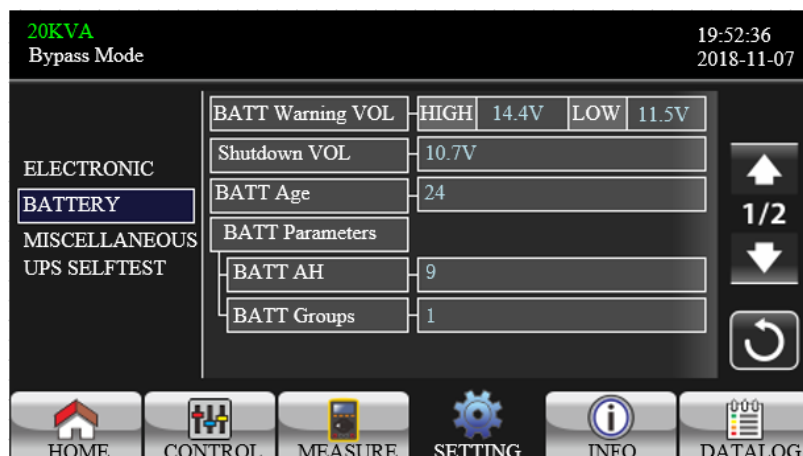

Battery setting page 1

- **BATT Warning VOL:**
 - **HIGH:** High battery warning voltage. The setting range is 14.0V ~ 15.0V. 14.4V is default setting.
 - **LOW:** Low battery warning voltage. The setting range is 10.1V ~ 14.0V. 11.4V is default setting. This parameter setting is related to "Shutdown Voltage" setting. The setting value should be higher than "Shutdown Voltage" setting.
- **Shutdown VOL:** If battery voltage is lower than this point in battery mode, UPS will automatically shut down. The setting range is 10.5V ~ 12.0V. 10.7V is default setting
- **BATT Age:** Set up battery age.
- **BATT Parameters:**
 - BATT AH: Set up battery capacity.
 - BATT Group: Set up battery group numbers.

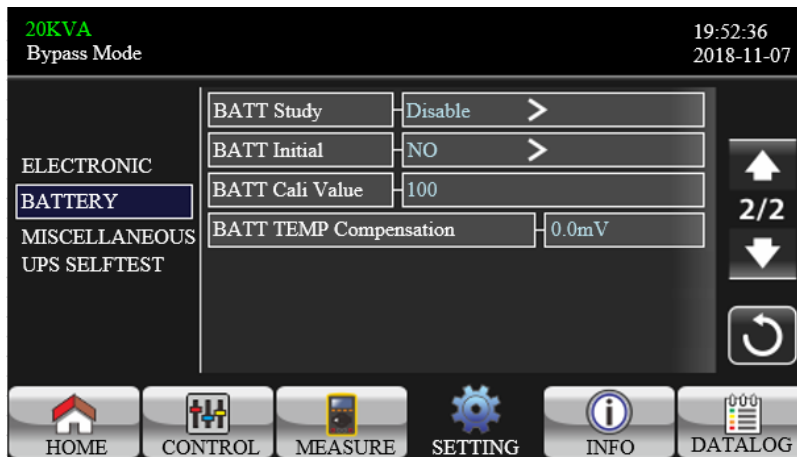

Battery setting page 2

- **Battery Study:** It's a self-learning function for battery.
 - **Enable:** When enabled, it will calibrate the battery virtual capacity and calculate backup time according to a complete charging and discharging process.
 - **Disable:** When disabled, the backup time will not be updated during the charging and discharging process.
- **Battery Initial:**
 - **Yes:** When selected, the battery virtual capacity will be initialized to 100%. Because battery study is a self-learning function, after the battery is used for a long time, the virtual capacity of the battery will be continuously updated based on each full charging process. After replacing the new battery, the virtual capacity of the battery needs to be initialized.
 - **No:** When selected, the virtual capacity of the battery will not be initialized.
- **BATT Cali Value:** Calibrate backup time.
- **BATT TEMP Compensation:** Compensate charging voltage according to battery temperature.

MISCELLANEOUS

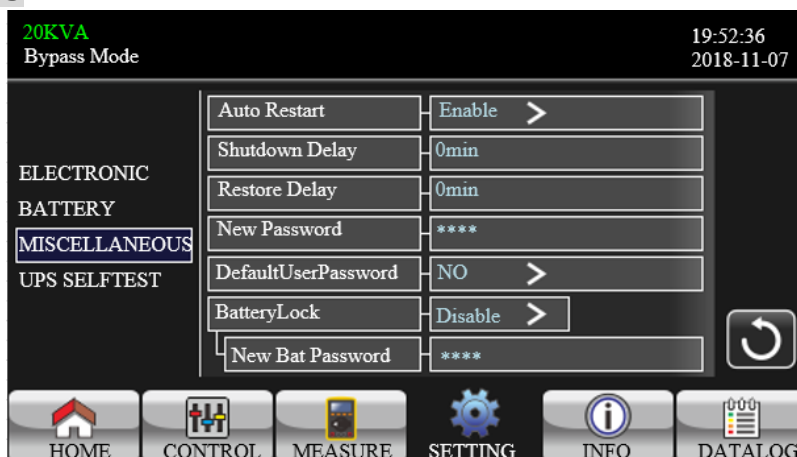

Miscellaneous setting page

- **Auto Restart:**
 - **Enable:** After "Enable" is set, once UPS shutdown occurs due to low battery and then utility restores, the UPS will return to line mode.
 - **Disable:** After "Disable" is set, once UPS shutdown occurs and the utility restores, the UPS will not automatically turn on.
- **Shutdown Delay:** UPS will shut down in setting minutes. The countdown will start after confirming the pop-up screen.
- **Restore Delay:** UPS will automatically restart in setting minutes after the UPS shuts down.
- **New Password:** Set up new password to enter "ADVANCE➔ User" menu page.
- **DefaultUserPassword:**
 - **YES:** After "YES" is set, User password will restore default setting value.
 - **NO:** After "NO" is set, the UPS will cancel this operation.
- **BatteryLock:** Currently, this setting is not available.

UPS SELFTEST

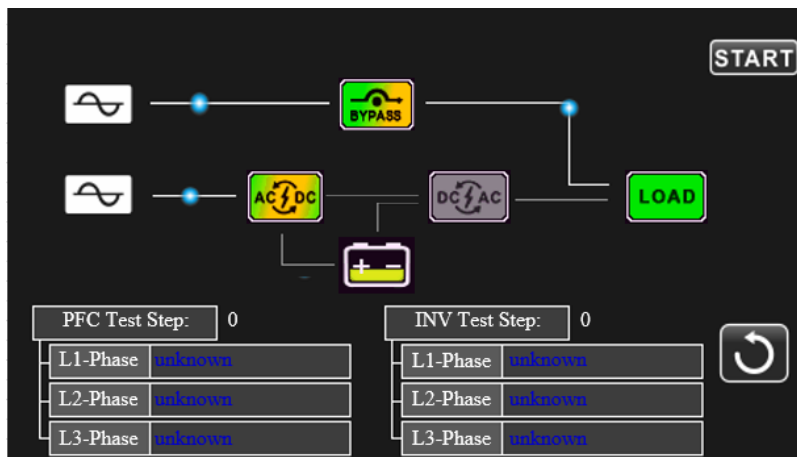

This function is only effective when UPS type setting is "HV". Therefore, please disconnect all loads and utility first before executing this function. Then, please change UPS type to "HV". For the detailed operation, please check "System Parameter" menu under Advance➔ Maintainer directory.

After changing UPS type to "HV", you have to restart the UPS. After the UPS is restarted, please enter Advance screen and enter Maintainer password. It will show "UPS SELFTEST" selection in the screen. In the screen, all tested items are shown "unknown". Simply click "UPS SELFTEST" button, the UPS will start self-test. If the UPS is normal, it will show "Normal" in all columns. Otherwise, "Unknown" will be displayed in the columns.

After the UPS self-test passes, the screen will be black automatically. If the UPS self-test is abnormal, it will stop on the abnormal screen. At this time, the maintenance personnel should repair the UPS according to the self-test instructions. Please check local dealer for self-test instructions.

3-2-5 Information screen

Touch the icon  to enter information page. Touch the icon  or  to browse information.

Touch the icon  to return to main screen. Touch the icon  to go back to previous menu.



Basic Information Page

Basic Information

- **MCU Version:** MCU version.
- **DSP Version:** DSP version.
- **Serial NO.:** The serial number of UPS.
- **Manufacturer:** The information about manufacturer.
- **Service Contact:** The contact name is set in "Basic Setting".
- **Service Phone:** The listed numbers are set in "Basic Setting".
- **Service Mail:** The service email account is set in "Basic Setting".



Basic Information Page 2

- **PAR State:** The information of parallel status.
- **PAR ID:** The UPS ID number in parallel status.
- **Customer Code:** Customer code.
- **DynamicPassword:** Enable/disable dynamic password.



Rated Information Page

Rated Information

- **Output VOL:** It shows output rated voltage.
- **Output FRE:** It shows output rated frequency.
- **CVCF Mode:** Enable/Disable CVCF mode.
- **Bypass Forbid:** Enable/disable bypass function.
- **Bypass UPS Off:** Enable/disable auto bypass function when UPS is off.
- **ECO Mode:** Enable/disable ECO function.
- **Auto Restart:** Enable/disable auto-restart function.



Parameter Information Page 1

Parameter Information



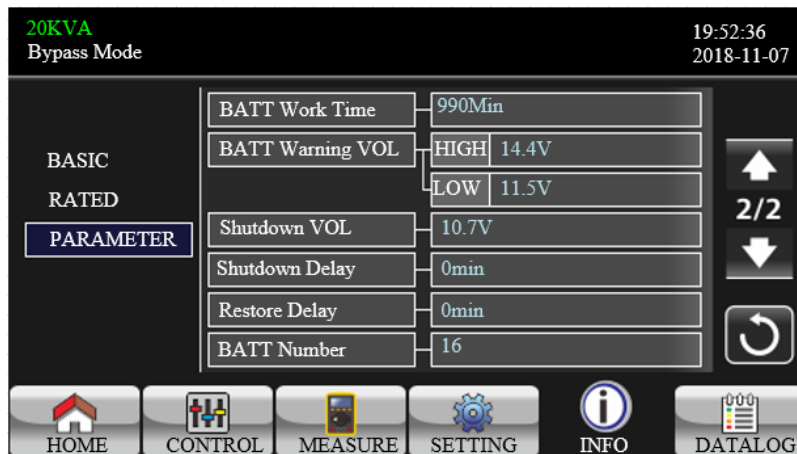

- **Line VOL Range:** The acceptable line input voltage range.
- **Line FRE Range:** The acceptable line input frequency range.
- **Bypass VOL Range:** The acceptable input voltage range for bypass mode.
- **Bypass FRE Range:** The acceptable input frequency range for bypass mode.
- **ECO VOL Range:** The acceptable input voltage range for ECO mode.
- **ECO FRE Range:** The acceptable input frequency range for ECO mode.



Parameter Information Page 2

- **BATT Work Time:** The maximum discharge time in battery mode.
- **BATT Warning VOL:**
 - **HIGH:** High battery warning voltage.
 - **LOW:** Low battery warning voltage.
- **Shutdown VOL:** If battery voltage is lower this point, UPS will automatically shut down.
- **Shutdown Delay:** UPS will shut down in setting minutes. The countdown will start after confirming the pop-up screen.
- **Restore Delay:** UPS will automatically restart in setting minutes after the UPS shuts down.
- **BATT Number:** It shows battery numbers.

3-2-6 Data Log screen

Touch the icon  to enter date log page. Data log is used to record the warning and fault information of the UPS. The record contains date & time, code, type and description. Touch the icon  or  to page up or down if there are more than one page in the date log. Touch the icon  to return to main screen. Press the icon  to go back to main menu. Please refer to Section 3-6 and 3-7 for warning and fault code list.

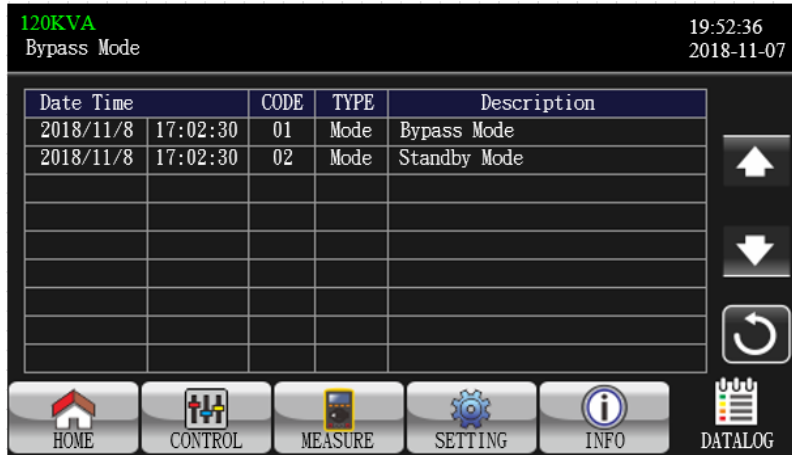

Data Log Page

3-3. Audible Alarm

Description	Buzzer status	Muted
UPS status		
Bypass mode	Beeping once every 2 minutes	Yes
Battery mode	Beeping once every 4 seconds	
Fault mode	Beeping continuously	
Warning		
Overload	Beeping twice every second	No
Others	Beeping once every second	
Fault		
All	Beeping continuously	Yes

3-4. Single UPS Operation

1. Turn on the UPS with utility power (in AC mode)

- 1) After power supply is connected correctly, set the breaker of the battery pack at "ON" position. Then set the line input breaker at "ON" position. At this time the fan is running and the UPS enter to power on mode for initialization, several seconds later, UPS operates in Bypass mode and supplies power to the load via the bypass.

NOTE: When UPS is in Bypass mode, the output voltage will directly power from utility after you switch on the input breaker. In Bypass mode, the load is not protected by the UPS. To protect your precious devices, you should turn on the UPS. Refer to next step.

- 2) Touch "CONTROL" and select "On/Off UPS" icon. It will show "Turn on UPS?" in screen and select "Yes". Refer to On/Off UPS screen.
- 3) A few seconds later, the UPS will enter into AC mode. If the utility is abnormal, the UPS will operate in Battery mode without interruption.

NOTE: When the UPS running out battery, it will shut down automatically at Battery mode. When the utility is restored, the UPS will auto restart in AC mode.

2. Turn on the UPS without utility power supply (in Battery mode)

- 1) Make sure that the two strings of batteries are connected correctly at UPS's "+,GND,-" terminals and the breaker of the battery pack is at "ON" position.
- 2) Press the "⏻ POWER" button to set up the power supply for the UPS. UPS will enter to power on mode. After initialization, UPS will enter to No Output mode.
- 3) A few seconds later, the UPS will be turned on and enter to Battery mode.

3. Connect devices to UPS

After the UPS is turned on, you can connect devices to the UPS.

- 1) Turn on the UPS first and then switch on the devices one by one. The LCD panel will display total load level.
- 2) If it is necessary to connect the inductive loads such as a printer, the in-rush current should be calculated carefully to see if it meets the capacity of the UPS, because the power consumption of this kind of loads is too big.
- 3) If the UPS is overload, the buzzer will beep twice every second.
- 4) When the UPS is overload, please remove some loads immediately. It is recommended to have the total loads connected to the UPS less than 80% of its nominal power capacity to prevent overload for system safety.
- 5) If the overload time is over acceptable time listed in spec at AC mode, the UPS will automatically transfer to Bypass mode. After the overload is removed, it will return to AC mode. At this time, if bypass is enabled, the UPS will power to the load via bypass. If bypass function is disabled or the input power is not within bypass acceptable range, it will cut off output directly. If the overload time is over acceptable time listed in spec at Battery mode, the UPS will become fault status.

4. Charge the batteries

- 1) After the UPS is connected to the utility power, the charger will charge the batteries automatically except in battery mode or during battery self-test or overload or battery high voltage.
- 2) Suggest to charge batteries at least 10 hours before use. Otherwise, the backup time may be shorter than expected.

5. Battery mode operation

- 1) When the UPS is in Battery mode, the buzzer will sound according to different battery capacity. If the battery capacity is more than 25%, the buzzer will beep once every 4 seconds. If the battery voltage drops to the alarm level, the buzzer will beep quickly (once every sec) to remind users that the battery is at low level and the UPS will shut down automatically soon. Users could switch off some non-critical loads to disable the shutdown alarm and prolong the backup time. If there is no more load to be switched off at that time, you have to shut down all loads as soon as possible to protect the devices or save data. Otherwise, there is a risk of data loss or load failure.
- 2) In Battery mode, users can touch "SETTING" → "Basic" → Audio Mute to enable "Mode Mute" to disable the buzzer.
- 3) The backup time of the long-run model depends on the external battery capacity.
- 4) The backup time may vary from different environment temperature and load type.
- 5) When backup time is displayed as 16.5 hours (default value), after discharging 16.5 hours, UPS will shut down automatically to protect the battery.

6. Test the batteries

- 1) If you need to check the battery status when the UPS is running in AC mode/CVCF mode, you could touch "CONTROL" and select "Battery Test". Refer to "Battery Test" screen.
- 2) Users also can set battery self-test through monitoring software.

7. Turn off the UPS with utility power supply in AC mode

- 1) Touch "CONTROL" and select "On/Off UPS" icon. It will show "Turn off UPS?" in screen and select "Yes". Refer to "On/Off UPS" screen.

NOTE 1: If the UPS has been set to bypass output, it will bypass voltage from the utility power to output terminal even though you have turned off the UPS (inverter).

NOTE 2: After turning off the UPS, please be aware that the UPS is working at Bypass mode and there is risk of power loss for connected devices.

- 2) In Bypass mode, output voltage of the UPS is still present. In order to cut off the output, switch off the line input breaker and switch off the bypass line breaker. A few seconds later, there is no display shown on the display panel and UPS is complete off.

8. Turn off the UPS without utility power supply in Battery mode

- 1) Touch "CONTROL" and select "On/Off UPS" icon. It will show "Turn off UPS?" in screen and select "Yes". Refer to "On/Off UPS" screen.
- 2) Then UPS will cut off power to output terminals.

9. Mute the buzzer

- 1) Touch "SETTING" and select "BASIC" item. There are two events available to mute. Refer to "SETTING" screen.
- 2) Some warning alarms can't be muted unless the error is fixed. Please refer to section 3-3 for details.

10. Operation in warning status

- 1) When warning code flashes and the buzzer beeps once every second, it means that a warning event occurs on UPS. Users can read the warning message(s) from "DATA LOG" menu. Please refer to the Section 3-2-6 for details.
- 2) Users can check warning codes in Section 3-7 and follow chapter 4 Troubleshooting to solve warning status.
- 3) Some warning alarms can't be muted unless the error is fixed. Please refer to section 3-3 for details.

11. Operation in Fault mode

- 1) When fault code lights on the LCD screen and the buzzer beeps continuously, it means that there is a fatal error with the UPS. Users can get the fault code from "DATA LOG" menu. Please refer to the Section 3-2-6 for details.
- 2) Please check the loads, wiring, ventilation, utility, battery and so on after the fault occurs. Don't try to turn on the UPS again before solving the issue. If the problems can't be fixed, please contact the distributor or service personnel immediately.
- 3) For emergency case, please cut off connection from utility, external battery, and output immediately to avoid possible damage to the UPS or equipment.

12. Operation in maintaining bypass mode

This operation is only available for professional or qualified technicians.

When the UPS needs to repair or service and then the load can't be shut off, the UPS needs to turn to maintenance mode.

- 1) First, turn off the UPS.
- 2) Second, remove the cover of maintenance bypass switch on the panel.
- 3) Third, turn the maintenance switch to "BPS" position and turn off the UPS input breaker and output breaker.

3-5. Parallel Operation

1. Parallel system initial startup

Please make sure that all of the running UPSs are parallel models and have the same configuration.

- 1) Turn on each UPS in AC mode respectively (Refer to section 3-4(1)). Then, measure the inverter output voltage of each phase for each UPS with a multi-meter. Calibrate the inverter output voltage by configuring inverter voltage adjustment (Refer to SETTING → Advance → Maintainer → VOL CALI → Inverter CALI screen) in LCD menu until the inverter output voltage difference of each UPS is within 1V or less.
- 2) Turn off each UPS (Refer to section 3-4(7.)). Then, follow the wiring procedure in section 2-4.
- 3) Remove the cover of parallel share current cable port on the UPS, connect each UPS one by one with the parallel cable and share current cable, and then screw the cover back.
- 4) **Turn on the parallel system in AC mode:**
 - a) Turn on the line input breaker of each UPS and turn on bypass input breaker). After all UPSs enter to bypass mode, measure the output voltage between two UPSs for the same phase to make sure the phase sequence is correct. If these two voltage differences are near to zero, that means all connections are met. Otherwise, please check if the wirings are connected correctly.
 - b) Turn on the output breaker of each UPS.
 - c) Turn on each UPS in turns. After a while, the UPSs will enter to AC mode synchronously and then, the parallel system is now complete.
- 5) **Turn on the parallel system in Battery mode:**
 - a) Turn on the battery breaker and output breaker of each UPS.
 - b) Turn on any UPS. A few seconds later, the UPS will enter to battery mode.
 - c) Turn on another UPS. A few seconds later, the UPSs enter to Battery mode and add to the parallel system.
 - d) If you have the third UPS, follow the same procedure of c). Then, the parallel system is complete.

If you would like to have more information regarding the parallel operation, please contact your supplier or service center for detail parallel operation instruction.

2. Add new units into the parallel system

- 1) You can't add one new unit into the parallel system when whole system is running. You must cut off the load and shutdown the system.
- 2) Make sure all of the UPS are the parallel models, and follow the wiring refer to section 2-4.
- 3) Install the new parallel system refers to the previous section.

3. Remove units from the parallel system

There are two methods to remove units from the parallel system:

First method:

- 1) Touch "CONTROL" → "Turn off UPS" and select "Yes" to turn of the UPS. Then, the UPS will enter into Bypass mode or No Output mode without output.
- 2) Turn off the output breaker of this unit, and then turn off the input breaker of this unit.
- 3) After it shuts down, you can turn off the battery breaker and remove the parallel and share current cables. And then remove the unit from the parallel system.

Second method:

- 1) If the bypass is abnormal, you cannot remove the UPS without interruption. You must cut off the load and shut down the system first.

- 2) Make sure the bypass setting is enabled in each UPS and then turn off the running system. All UPSs will transfer to Bypass mode. Remove all the maintenance bypass covers and set the maintenance switches from "UPS" to "BPS" position. Turn off all the input breakers and battery breakers in parallel system.
- 3) Turn off the output breaker and remove the parallel cable and share current cable of the UPS which you want to remove. Now, you can remove the UPS from parallel system.
- 4) Turn on the input breaker of the remaining UPS and the system will transfer to Bypass mode. Set the maintenance switches from "BPS" to "UPS" position and put the maintenance bypass covers back on.
- 5) Turn on the remaining UPS according to the previous section.



Warning: (Only for the parallel system)

- Before turning on the parallel system to activate inverter, make sure that all unit's maintenance switch at the same position.
- When parallel system is turned on, please do not operate the maintenance switch of any unit.
- Please Do NOT enable the ECO mode in parallel system.

3-6. Fault Code

Fault code	Fault event	Fault code	Fault event
01	Bus start failure	42	DSP communication failure
02	Bus over	43	Overload
03	Bus under	46	Incorrect UPS setting
04	Bus unbalance	47	MCU communication failure
06	Converter over current	48	Two DSP firmware versions are incompatible in parallel system.
11	Inverter soft start failure	60	Bypass phase short circuited
12	High inverter voltage	61	Bypass SCR short circuited
13	Low inverter voltage	62	Bypass SCR open circuited
14	Inverter L1 output(line to neutral) short circuited	63	Voltage waveform abnormal in L1 phase
15	Inverter L2 output(line to neutral) short circuited	64	Voltage waveform abnormal in L2 phase
16	Inverter L3 output(line to neutral) short circuited	65	Voltage waveform abnormal in L3 phase
17	Inverter L1-L2 output (line to line) short circuited	66	Inverter current detect abnormal
18	Inverter L2-L3 output (line to line) short circuited	67	Bypass O/P short circuited
19	Inverter L3-L1 output (line to line) short circuited	68	Bypass O/P line to line short circuited
1A	Inverter L1 negative power fault	69	Inverter SCR short circuited
1B	Inverter L2 negative power fault	6C	BUS voltage drops too fast
1C	Inverter L3 negative power fault	6D	Current error value detect
21	Battery SCR short circuited	6E	SPS power error
23	Inverter relay circuited open	6F	Battery polarity reverse
24	Inverter relay short circuited	71	PFC IGBT over-current in L1 phase
25	Line wiring fault	72	PFC IGBT over-current in L2 phase
31	Parallel communication failure	73	PFC IGBT over-current in L3 phase
32	The host signal failure	74	INV IGBT over-current in L1 phase
33	Synchronous signal failure	75	INV IGBT over-current in L2 phase
34	Synchronous trigger signal failure	76	INV IGBT over-current in L3 phase
35	Parallel communication loss	77	ISO Over temperature
36	Parallel output current unbalance	78	LCD&MCU communication failed
41	Over temperature		

3-7. Warning Code

Warning code	Warning event	Warning code	Warning event
01	Battery unconnected	21	Line situations are different in parallel system
02	IP Neutral loss	22	Bypass situations are different in parallel system
04	IP phase abnormal	33	Locked in bypass after overload 3 times in 30 minutes
05	Bypass phase abnormal	34	Converter current unbalanced
07	Over charge	3A	Cover of maintain switch is open
08	Low battery	3C	Utility extremely unbalanced
09	Overload	3D	Bypass is unstable
0A	Fan failure	3E	Battery voltage too high
0B	EPO enable	3F	Battery voltage unbalanced
0D	Over temperature	40	Charger short circuited
0E	Charger failure		

4. Trouble Shooting

If the UPS system does not operate correctly, please solve the problem by using the table below.

Symptom	Possible cause	Remedy
No indication and alarm in the front display panel even though the mains is normal.	The AC input power is not connected well.	Check if input cable firmly connected to the mains.
The warning code 0B.	EPO function is activated. At this time, the EPO switch is in "OFF" status or the jumper is open.	Set the circuit in closed position to disable the EPO function.
The warning code 01.	The external or internal battery is incorrectly connected.	Check if all batteries are connected well.
The warning code 09.	UPS is overload.	Remove excess loads from UPS output.
	UPS is overloaded. Devices connected to the UPS are fed directly by the electrical network via the Bypass.	Remove excess loads from UPS output.
	After repetitive overloads, the UPS is locked in the Bypass mode. Connected devices are fed directly by the mains.	Remove excess loads from UPS output first. Then shut down the UPS and restart it.
Fault code is shown as 43.	UPS is overload too long and becomes fault. Then UPS shut down automatically.	Remove excess loads from UPS output and restart it.
Fault code is shown as 14, 15, 16, 17, 18 or 19.	The UPS shut down automatically because short circuit occurs on the UPS output.	Check output wiring and if connected devices are in short circuit status.
Other fault codes are shown on LCD display and alarm beeps continuously.	A UPS internal fault has occurred.	Contact your dealer
Battery backup time is shorter than nominal value	Batteries are not fully charged.	Charge the batteries for at least 7 hours and then check capacity. If the problem still persists, consult your dealer.
	Batteries defect	Contact your dealer to replace the battery.
The warning code 0A.	Fan is locked or not working. Or the UPS temperature is too high.	Check fans and notify dealer.
The warning code 02.	The input neutral wire is disconnected.	Check and correct the input neutral connection. If the connection is ok and the warning is still displaying, please enter LCD setting menu →ADVANCE→User→Electronic. Then, select "CHE" in Neutral Line Check item and restart the UPS.
	The L2 or L3 input fuse is broken.	Replace the fuse.

5. Storage and Maintenance

5-1. Storage

Before storing, charge the UPS at least 7 hours. Store the UPS covered and upright in a cool, dry location. During storage, recharge the battery in accordance with the following table:

Storage Temperature	Recharge Frequency	Charging Duration
-25°C - 40°C	Every 3 months	1-2 hours
40°C - 45°C	Every 2 months	1-2 hours

5-2. Maintenance



The UPS system operates with hazardous voltages. Repairs may be carried out only by qualified maintenance personnel.



Even after the unit is disconnected from the mains, components inside the UPS system are still connected to the battery packs which are potentially dangerous.



Before carrying out any kind of service and/or maintenance, disconnect the batteries and verify that no current is present and no hazardous voltage exists in the terminals of high capability capacitor such as BUS-capacitors.



Only persons are adequately familiar with batteries and with the required precautionary measures may replace batteries and supervise operations. Unauthorized persons must be kept well away from the batteries.



Verify that no voltage between the battery terminals and the ground is present before maintenance or repair. In this product, the battery circuit is not isolated from the input voltage. Hazardous voltages may occur between the battery terminals and the grounding/earthing.



Batteries may cause electric shock and have a high short-circuit current. Please remove all wristwatches, rings and other metal person objects before maintenance or repair, and only use tools with insulated grips and handles for maintaining or repairing.



When replace the batteries, install the same number and same type of batteries.



Do not attempt to dispose of batteries by burning them. This could cause battery explosion. The batteries must be deposited according to local environmental regulations.



Do not open or destroy batteries. Escaping electrolyte can cause injury to the skin and eyes. It may be toxic.



Please replace the fuse only with the same type and amperage in order to avoid fire hazards.



Do not disassemble the UPS system.

6. Specifications

400V system

MODEL		30K	60K	100K	120K	180K	200K
CAPACITY*		30KVA/30KW	60KVA/60KW	100KVA/100K W	120KVA/120K W	180KVA/180K W	200KVA/200K W
INPUT							
Voltage Range	Low Line Loss	110 VAC(Ph-N) \pm 3 % at 50% Load 176 VAC(Ph-N) \pm 3 % at 100% Load					
	Low Line Comeback	Low Line Loss Voltage + 10V					
	High Line Loss	300 VAC(L-N) \pm 3 % at 50% Load 276 VAC(L-N) \pm 3 % at 100% Load					
	High Line Comeback	High Line Loss Voltage - 10V					
Frequency Range		46Hz ~ 54 Hz @ 50Hz system 56Hz ~ 64 Hz @ 60Hz system					
Phase		3 Phase with Neutral					
Power Factor		\geq 0.99 at 100% Load					
OUTPUT							
Phase		3 Phase with Neutral					
Output voltage		360*/380/400/415VAC (Ph-Ph) 208*/220/230/240VAC (Ph-N)					
AC Voltage Regulation		\pm 1%					
Frequency Range (Synchronized Range)		46Hz ~ 54 Hz @ 50Hz system 56Hz ~ 64 Hz @ 60Hz system					
Frequency Range (Batt. Mode)		50/ 60 Hz \pm 1%					
Overload	AC mode	100%~110%: 60min; 111%~125%: 10min; 126%~150%: 1min; >150%: 400ms					
	Battery mode	100%~110%: 60min; 111%~125%: 10min; 126%~150%: 1min; >150%: 400ms					
Current Crest Ratio		3:1 max					
Harmonic Distortion		\leq 1 % @ 100% Linear Load; \leq 3 % @ 100% Non-linear Load					
Transfer Time	Line \leftrightarrow Battery	0 ms					
	Inverter \leftrightarrow Bypass	0 ms					
	Inverter \leftrightarrow ECO	(When phase lock fails, <4ms interruption occurs from inverter to bypass) <10 ms					
EFFICIENCY							
AC Mode		95.5%					
ECO Mode		98.5%					
Battery Mode		94.5%					
BATTERY							
Type		Depending on applications					
Numbers		32 ~ 40 (adjustable)					
Charging Current(max.)		1~12A (adjustable)	1~18A (adjustable)	2~36A (adjustable)		3~54A (adjustable)	
Charging Voltage		+/- 13.65 VDC * N \pm 1% (N = 16~20)					
PHYSICAL							
Standard Model	Dimension, D X W X H mm	815 x 300 x 1000		NA			
	Net Weight (kgs)	207		NA			
Long-run Model	Dimension, D X W X H mm	815 x 300 x 1000		974 x 600 x 1600			
	Net Weight (kgs)	74	87	241	286	286	382
ENVIRONMENT							
Operation Temperature		0 ~ 40°C (the battery life will be reduced when > 25°C)					
Operation Humidity		<95 % and non-condensing					
Operation Altitude**		<1500m**					
Protection		IP20					
Acoustic Noise Level		Less than 65dB@1 Meter	Less than 70dB @1 Meter	Less than 75dB @1 Meter			
MANAGEMENT							
Smart RS-232 or USB		Supports Windows® 2000/2003/XP/Vista/2008/7/8/10, Linux, Unix, and MAC					
Optional SNMP		Power management from SNMP manager and web browser					

* Derate capacity to to 90% when the output voltage is adjusted to 3 x 360VAC.

**If the UPS is installed or used in a place where the altitude is above than 1000m, the output power must be derated 1% per 100m.

***Product specifications are subject to change without further notice.