

User Manual

PowerWalker VI CW Series

Uninterruptible Power Supply System

Table of Contents

1. Important Safety Warning	1
1-1. Transportation	1
1-2. Preparation.....	1
1-3. Installation	1
1-4. Operation	1
1-5. Maintenance, service and faults	2
2. Installation And Setup.....	4
2-1. Rear panel view	4
2-2. Operating principle	5
2-3. Setup the UPS	5
3. Operations	7
3-1. Button operation.....	7
3-2. LCD Panel.....	7
3-3. Audible Alarm	8
3-4. LCD display wordings index	9
3-5. UPS Setting	9
3-6. Operating Mode Description.....	12
3-7. Faults Reference Code.....	12
3-8. Warning indicator	13
4. Troubleshooting.....	14
5. Storage and Maintenance	15
6. Specifications	16

1. Important Safety Warning

Please comply with all warnings and operating instructions in this manual strictly. Save this manual properly and read carefully the following instructions before installing the unit. Do not operate this unit before reading through all safety information and operating instructions carefully

1-1. Transportation

- Please transport the UPS system only in the original package to protect against shock and impact.

1-2. Preparation

- Condensation may occur if the UPS system is moved directly from cold to warm environment. The UPS system must be absolutely dry before being installed. Please allow at least two hours for the UPS system to acclimate the environment.
- Do not install the UPS system near water or in moist environments.
- Do not install the UPS system where it would be exposed to direct sunlight or near heater.
- Do not block ventilation holes in the UPS housing.

1-3. Installation

- Do not connect appliances or devices which would overload the UPS system to the UPS output sockets.
- Place cables in such a way that no one can step on or trip over them.
- Do not connect domestic appliances such as hair dryers to UPS output sockets.
- The UPS can be operated by any individuals with no previous experience.
- Connect the UPS system only to an earthed shockproof outlet which must be easily accessible and close to the UPS system.
- Please use only VDE-tested, CE-marked (or UL-marked for 110/115/120/127 VAC models) mains cable (e.g. the mains cable of your computer) to connect the UPS system to the building wiring outlet (shockproof outlet).
- Please use only VDE-tested, CE-marked (or UL-marked for 110/115/120/127 VAC models) power cables to connect the loads to the UPS system.
- When installing the equipment, it should ensure that the sum of the leakage current of the UPS and the connected devices does not exceed 3.5mA.
- Temperature Rating - Units are considered acceptable for use in a maximum ambient of 40°C (104°F).
- For Pluggable Equipment - The socket-outlet shall be installed near the equipment and shall be easily accessible.

1-4. Operation

- Do not disconnect the mains cable on the UPS system or the building wiring outlet (shockproof socket outlet) during operations since this would cancel the protective earthing of the UPS system and of all connected loads.
- The UPS system features its own, internal current source (batteries). The UPS output sockets or output terminals block may be electrically live even if the UPS system is not connected to the building wiring outlet.
- In order to fully disconnect the UPS system, first press the OFF/Enter button to disconnect the mains.
- Prevent no fluids or other foreign objects from inside of the UPS system.

1-5. Maintenance, service and faults

- The UPS system operates with hazardous voltages. Repairs may be carried out only by qualified maintenance personnel.
- **Caution** - risk of electric shock. Even after the unit is disconnected from the mains (building wiring outlet), components inside the UPS system are still connected to the battery and electrically live and dangerous.
- Before carrying out any kind of service and/or maintenance, disconnect the batteries and verify that no current is present and no hazardous voltage exists in the terminals of high capability capacitor such as BUS-capacitors.
- Only persons are adequately familiar with batteries and with the required precautionary measures may replace batteries and supervise operations. Unauthorized persons must be kept well away from the batteries.
- **Caution** - risk of electric shock. The battery circuit is not isolated from the input voltage. Hazardous voltages may occur between the battery terminals and the ground. Before touching, please verify that no voltage is present!
- **Caution** - Do not dispose of batteries in a fire. The batteries may explode.
- **Caution** - Do not open or mutilate batteries. Released electrolyte is harmful to the skin and eyes. It may be toxic.
 - a) Batteries may cause electric shock and have a high short-circuit current. Please take the precautionary measures specified below and any other measures necessary when working with batteries: Remove watches, rings, or other metal objects.
 - b) Use tools with insulated handles.
 - c) Wear rubber gloves and boots.
 - d) Do not lay tools or metal parts on top of batteries.
 - e) Disconnect charging source and load prior to installing or maintaining the battery.
 - f) Remove battery grounds during installation and maintenance to reduce likelihood of shock. Remove the connection from ground if any part of the battery is determined to be grounded.
- When changing batteries, install the same number and same type of batteries.

Manufacture	Type	Rated
Toplite (Guangzhou) Technology Battery Co Ltd (MH29104)	NPW45-12	12 V dc, 9.0 Ah
	UXW460-12	12 V dc, 9.0 Ah
	NPW36-12	12 V dc, 7.2 Ah
	UXW360-12	12 V dc, 7.2 Ah
	NPW45-12 FR	12 V dc, 7.0 Ah
	UXW460-12/FR	12 V dc, 7.0 Ah
	NPW36-12 FR	12 V dc, 7.0 Ah
CSB Battery Co Ltd (MH14533)	UXW360-12/FR	12 V dc, 7.0 Ah
	GP1272	12 V dc, 7.2 Ah
	UPS 12460 F2	12 V dc, 9.0 Ah
	UPS 12360 6	12 V dc, 6.5 Ah
	UPS 12360 7	12 V dc, 6.5 Ah
	HR 1234W	12 V dc, 8.5 Ah
	HR 1234W FR	12 V dc, 8.5 Ah
Yuasa Battery (Guangdong) Co Ltd (MH29616)	NPW45-12	12 V dc, 8.0 Ah
	NPW45-12FR	12 dc, 8.0 Ah

- For UPS with internally mounted battery
 - a) Instructions shall carry sufficient information to enable the replacement of the battery with a suitable manufacturer and catalogue number.
 - b) Safety instructions to allow access by Service Personnel shall be stated in the installation/service handbook.
 - c) If batteries are to be installed by Service Personnel, instructions for interconnections, including terminal torque, shall be provided.
- Do not attempt to dispose of batteries by burning them. This could cause battery explosion.
- Do not open or destroy batteries. Escaping electrolyte can cause injury to the skin and eyes. It may be toxic.
- Please replace the fuse only with the same type and amperage in order to avoid fire hazards.
- Do not dismantle the UPS system.
- **WARNING:** This is a category C2 UPS product. In a residential environment, this product may cause radio interference, in which case the user may be required to take additional measures. (only for 220/230/240 VAC system)

Only for 110/115/120/127 VAC system:

- **NOTE:** This equipment has been tested and found to comply with the limits for a Class A digital device, pursuant to part 15 of the FCC Rules. These limits are designed to provide reasonable protection against harmful interference when the equipment is operated in a commercial environment. This equipment generates, uses, and can radiate radio frequency energy and, if not installed and used in accordance with the instruction manual, may cause harmful interference to radio communications. Operation of this equipment in a residential area is likely to cause harmful interference in which case the user will be required to correct the interference at his own expense.
- **WARNING:** Changes or modifications not expressly approved by the party responsible for compliance could void the user's authority to operate the equipment.

2. Installation And Setup

NOTE: Before installation, please inspect the unit. Be sure that nothing inside the package is damaged. Please keep the original package in a safe place for future use.

2-1. Rear panel view

IEC Type

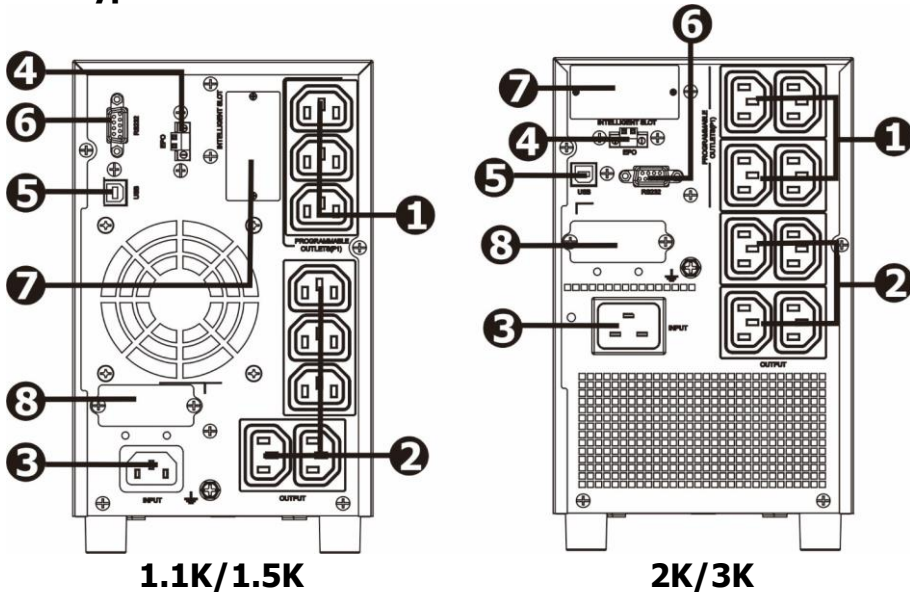

NEMA Type

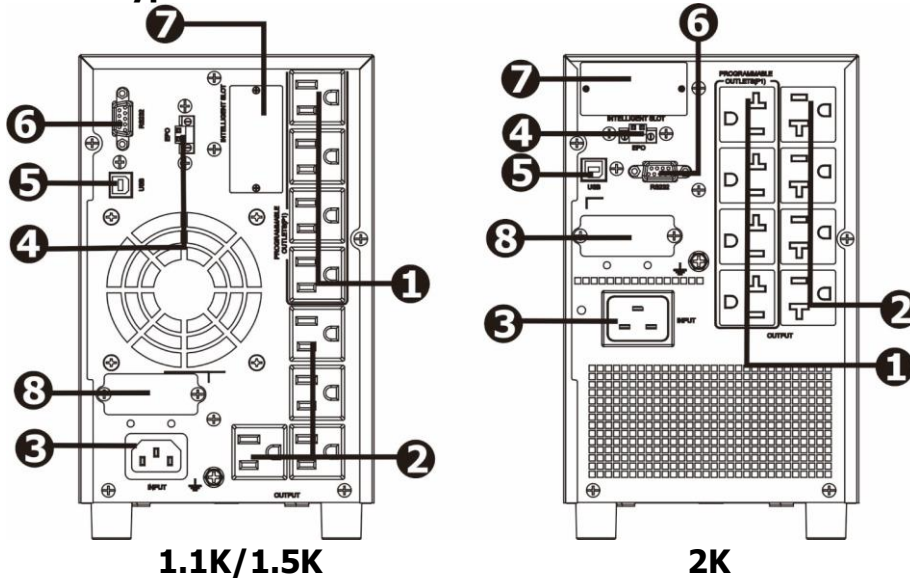

1. Programmable outlets: connect to non-critical loads.
2. Output receptacles: connect to mission-critical loads.
3. AC input
4. Emergency power off function connector (EPO)
5. USB communication port
6. RS-232 communication port
7. SNMP intelligent slot
8. External battery connector Output terminal

2-2. Operating principle

The operating principle of the UPS is shown as below.

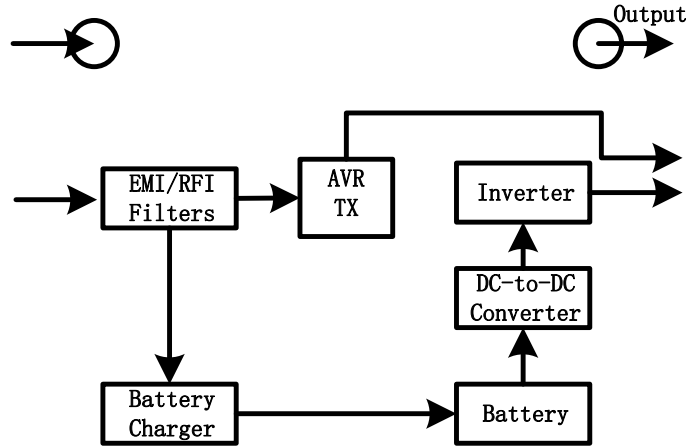

The UPS is composed of mains input, EMI/RFI filters, inverter, battery charger, DC-to-DC converter, battery, AVR TX and UPS output

2-3. Setup the UPS

Before installing the UPS, please read below to select proper location to install UPS.

- UPS should be placed on the flat and clean surface. Place it in an area away from vibration, dust, humidity, high temperature, flammable liquids, gases, corrosive and conductive contaminants. Install the UPS indoors in a clean environment, where it is away from window and door. Maintain minimum clearance of 100mm in the bottom of the UPS to avoid dust and high temperature.

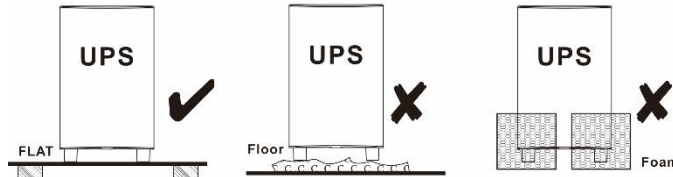

- Maintain an ambient temperature range of 0°C to 45°C for UPS optimal operation. For every 5°C above 45°C, the UPS will derate 12% of nominal capacity at full load. The highest working temperature requirement for UPS operation is 50°C.
- It's required to maintain maximum altitude of 1000m to keep UPS normal operation at full load UPS. If it's used in high altitude area, please reduce connected load. Altitude derating power with connected loads for UPS normal operation is listed as below:

Altitude m	Derating factor ⁽¹⁾
1 000	1.0
1 500	0.95
2 000	0.91
2 500	0.86
3 000	0.82
3 500	0.78
4 000	0.74
4 500	0.7
5 000	0.67

NOTE - Note to table 1
Based on density of dry air = 1.225 kg/m³ at sea-level, +15 °C.
⁽¹⁾ Since fans lose efficiency with altitude, forced air-cooled equipment will have a smaller derating.

- Place UPS:

It's equipped with fan for cooling. Therefore, place the UPS in a well-ventilated area. It's required to maintain minimum clearance of 100mm in the front of the UPS and 300mm in the back and two sides of the UPS for heat dissipation and easy-maintenance.

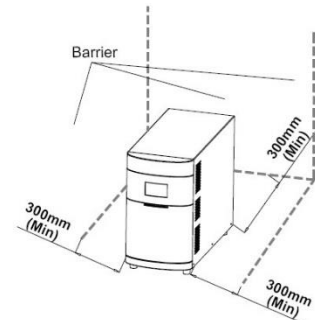

Step 1: UPS input connection

Plug the UPS into a two-pole, three-wire, grounded receptacle only. Avoid using extension cords.

Step 2: UPS output connection

There two kinds of outputs: programmable outlets and general outlets. Please connect non-critical devices to the programmable outlets and critical devices to the general outlets.

During power failure, you may extend the backup time to critical devices by setting shorter backup time for non-critical devices.

Step 3: Communication connection

Communication port:

USB port



RS-232 port

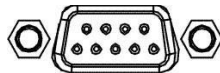

Intelligent slot



To allow for unattended UPS shutdown/start-up and status monitoring, connect the communication cable one end to the USB/RS-232 port and the other to the communication port of your PC. With the monitoring software installed, you can schedule UPS shutdown/start-up and monitor UPS status through PC.

The UPS is equipped with intelligent slot perfect for either SNMP or AS400 card. When installing either SNMP or AS400 card in the UPS, it will provide advanced communication and monitoring options.

Step 4: Disable and enable EPO function

This UPS is equipped with EPO function. By default, the UPS is delivered from factory with Pin 1 and pin 2 closed (a metal plate is connected to Pin 1 and Pin2) for UPS normal operation. To activate EPO function, remove two screws on EPO port and green connector will be removed.

Note: The EPO function logic can be set up via LCD setting. Please refer to program 8 in UPS setting for the details.

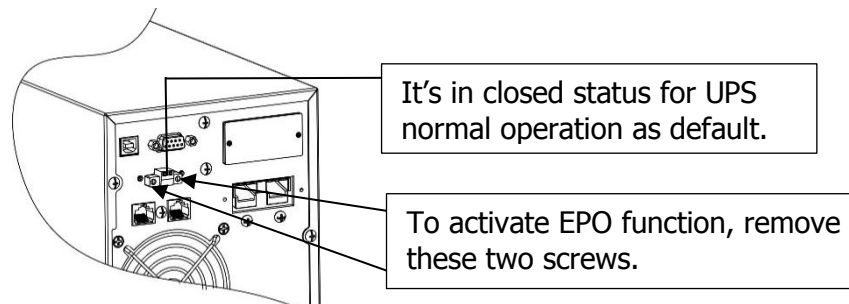

Step 5: Turn on the UPS

Press the ON/Mute button on the front panel for two seconds to power on the UPS.

Note: The battery charges fully during the first five hours of normal operation. Do not expect full battery run capability during this initial charge period.

Step 6: Install software

For optimal computer system protection, install UPS monitoring software to fully configure UPS shutdown. Use supplied RS-232 or USB communication cable to connect RS-232/USB port of UPS and RS-232/USB port of PC. Then, follow below steps to install monitoring software.

1. Insert the included installation CD into CD-ROM drive and then follow the on-screen instructions to proceed software installation. If there no screen shows 1 minute after inserting the CD, please execute setup.exe file for initiating software installation.
2. Follow the on-screen instructions to install the software.
3. When your computer restarts, the monitoring software will appear as an orange plug icon located in the system tray, near the clock.

3. Operations







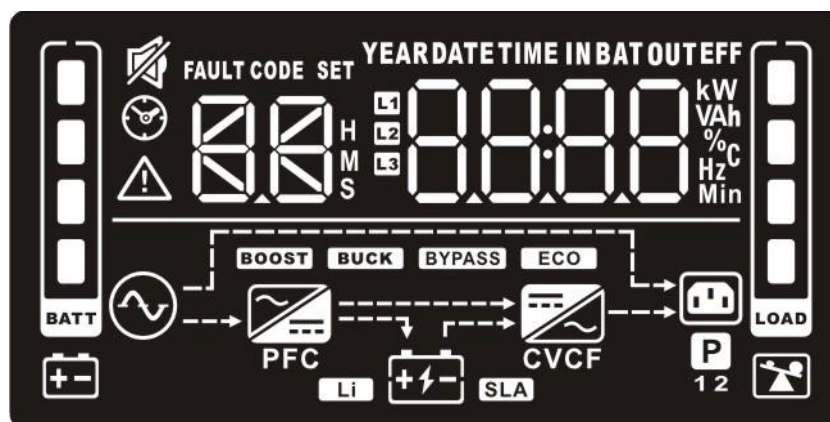



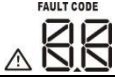





3-1. Button operation

Button	Function
ON/MUTE Button	<ul style="list-style-type: none"> ➤ Turn on the UPS: Press and hold ON/Mute button for at least 2 seconds to turn on the UPS. ➤ Mute the alarm: After the UPS is turned on in battery mode, press and hold this button for at least 3 seconds to disable or enable the alarm system. But it's not applied to the situations when warnings or errors occur. ➤ Up key: Press this button to display previous selection in UPS setting mode. ➤ Switch to UPS self-test mode: Press and hold ON/Mute button for 3 seconds to enter UPS self-testing while in AC mode
OFF/ENTER Button	<ul style="list-style-type: none"> ➤ Turn off the UPS: Press and hold this button at least 2 seconds to turn off the UPS ➤ Confirm selection key: Press this button to confirm selection in UPS setting mode.
SELECT Button	<ul style="list-style-type: none"> ➤ Switch LCD message: Press this button to change the LCD message for input voltage, input frequency, battery voltage, battery capacity, ambient temperature, output voltage, output frequency, load current and load percentage. ➤ Setting mode: Press and hold this button for 3 seconds to enter UPS setting mode when UPS is off. ➤ Down key: Press this button to display next selection in UPS setting mode.
ON/Mute + Select Button	<ul style="list-style-type: none"> ➤ Exit setting mode or return to the upper menu: When working in setting mode, press ON/Mute and Select buttons simultaneously for 0.2 seconds to return to the upper menu. If it's already in top menu, press these two buttons at the same time to exit the setting mode.

3-2. LCD Panel



Display	Function
Backup time information	
	Indicates the estimated backup time. H: hours, M: minute, S: second.

Configuration and fault information	
	Indicates the configuration items, and the configuration items are listed in details in section 3-5.
	Indicates the warning and fault codes, and the codes are listed in details in section 3-7 and 3-8.
Mute operation	
	Indicates that the UPS alarm is disabled.
Input, Battery, Temperature, Output & Load information	
	Indicate the input voltage, input frequency, battery voltage, battery capacity, ambient temperature, output voltage, output frequency, load current and load percentage. k: kilo, W: watt, V: voltage, A: ampere, %: percent, °C: centigrade degree, Hz: frequency
Load information	
	Indicates the load level by 0-24%, 25-49%, 50-74% and 75-100%.
	Indicates overload.
Programmable outlets information	
	Indicates that programmable management outlets are working.
Mode operation information	
	Indicates the UPS connects to the mains.
	Indicates the battery is working.
	Indicates charging status
	Indicates the ECO mode is enabled.
	Indicates the UPS is working in boost mode
	Indicates the UPS is working in buck mode
	Indicates the AC to DC circuit is working.
	Indicates the inverter circuit is working.
	Indicates the output is working.
Battery information	
	Indicates the battery level by 0-24%, 25-49%, 50-74%, and 75-100%.
	Indicates low battery.

3-3. Audible Alarm

Battery Mode	Sounding every 10 seconds
Low Battery	Sounding every 2 seconds
Overload	Sounding every second
Fault	Continuously sounding

3-4. LCD display wordings index

Abbreviation	Display content	Meaning
ENA	ENa	Enable
DIS	dI S	Disable
ESC	ESc	Escape
AO	AO	Active Open
AC	AC	Active Close
OK	OK	OK
ON	ON	ON
BL	bL	Battery Low
OL	OL	Over Load
NC	nC	No Connect
OC	OC	Over Charge
SF	SF	Site wiring fault
EP	EP	EPO
TP	tP	Temperature
CH	CH	Charger
BF	bF	Battery Fault
BR	bR	Battery Replace
EE	EE	EEPROM error

3-5. UPS Setting

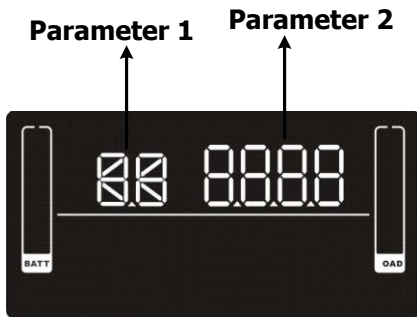

There are two parameters to set up the UPS.
 Parameter 1: It's for program alternatives. Refer to below table.
 Parameter 2 is the setting options or values for each program.

● 01: Output voltage setting

Interface	Setting
	<p>Parameter 2: Output voltage For 208/220/230/240 VAC models, you may choose the following output voltage: 208: presents output voltage is 208Vac 220: presents output voltage is 220Vac 230: presents output voltage is 230Vac (Default) 240: presents output voltage is 240Vac For 110/115/120/127 VAC models, you may choose the following output voltage: 110: presents output voltage is 110Vac</p>

	115: presents output voltage is 115Vac 120: presents output voltage is 120Vac (Default) 127: presents output voltage is 127Vac
--	---

● **02: Programmable outlets enable/disable**

Interface	Setting
	Parameter 2: Enable or disable programmable outlets. ENA: Programmable outlets enable DIS: Programmable outlets disable (Default)

● **03: Programmable outlets setting**

Interface	Setting
	Parameter 2: Set up backup time limits for programmable outlets. 0-999: setting the backup time limits in minutes from 0-999 for programmable outlets which connect to non-critical devices on battery mode. (Default: 999)

● **04: Maximum charger current setting**

Interface	Setting
	Parameter 2: Set up the charger maximum current. 1/2/4/6/8: setting the maximum charger current at 1/2/4/6/8 Ampere. (Default: 8A) Note: This setting is only effective for super charger.

● **06: Autonomy limitation setting**

Interface	Setting
	Parameter 2: Set up backup time on battery mode for general outlets. 0-999: setting the backup time in minutes from 0-999 for general outlets on battery mode. DIS: Disable the autonomy limitation and the backup time will depend on battery capacity. (Default) Note: When setting as "0", the backup time will be only 10 seconds.

● **07: Battery total AH setting**

Interface	Setting
	Parameter 2: Set up the battery total AH of the UPS. 7-999: setting the battery total capacity from 7-999 in AH. Please set the correct battery total capacity if external battery bank is connected.





● **08: EPO logic setting**

Interface	Setting
	<p>Parameter 2: Set up the EPO function control logic.</p> <p>AO: Active Open (Default). When AO is selected as EPO logic, it will activate EPO function with Pin 1 and Pin 2 in open status.</p> <p>AC: Active Close. When AC is selected as EPO logic, it will activate EPO function with Pin 1 and Pin 2 in close status.</p>

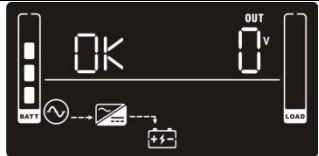

● **00: Exit setting**

Interface	Setting
	Exit the setting mode.

Steps for setting programmable outlet

<p>Step 1: Before entering setting mode, the UPS should be in Stand-by mode (off-charging) and make sure the battery is connected. The LCD display is shown as right.</p>	
<p>Step 2: Press and hold the "Selection" button for 3 seconds to enter Setting mode.</p>	
<p>Step 3: Press the "Up" button (ON/MUTE) to switch to "02" of program list. Then press "Enter" button to enter value setting of parameter 2. Press the "Up" button to change the value to "ENA" to enable the programmable outlet function. Then press "Enter" button again to confirm the setting.</p>	
<p>Step 4: Press the "Up" button (ON/MUTE) again to switch to "03" of program list. Then press "Enter" button for setting programmable outlet time. Push "Up" button to change the value of backup time according your demand. Then press "Enter" to confirm the setting.</p>	
<p>Step 5: Press "Up" button (ON/MUTE) to switch to "00" of program list. Then press "Enter" button to exit setting menu.</p>	
<p>Step 6: Disconnect AC input and wait until the LCD display is off. The new setting will be activated when turning on the UPS again.</p>	

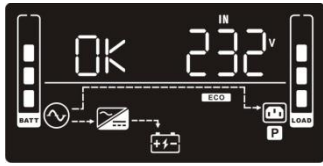
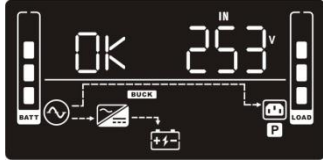
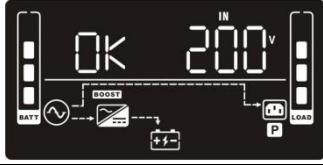

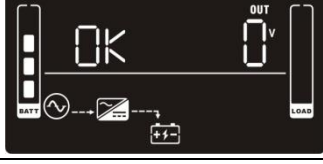
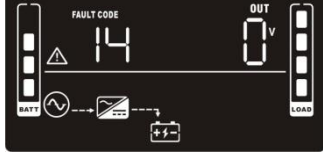





3-6. Operating Mode Description

Operating mode	Description	LCD display
ECO mode	When the input voltage is within voltage regulated range, UPS will power the output directly from the mains. ECO is an abbreviation of Efficiency Corrective Optimizer. In this mode, when battery is fully charged, the fan will stop working for energy saving.	
Buck mode when AC is normal.	When the input voltage is higher than the voltage regulation range but lower than high loss point, the buck AVR will be activated.	
Boost mode when AC is normal.	When the input voltage is lower than the voltage regulation range but higher than low loss point, the boost AVR will be activated.	
Battery mode	When the input voltage is beyond the acceptable range or power failure, UPS will backup power from battery and alarm is sounding every 10 seconds.	
Standby mode	UPS is powered off and no output supply power, but still can charge batteries.	
Fault mode	When a fault occurs, the ERROR icon and the fault code will be displayed.	

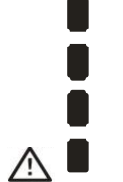
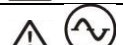
3-7. Faults Reference Code

Fault event	Fault code	Icon	Fault event	Fault code	Icon
Bus start fail	01	x	Inverter output short	14	x
Bus over	02	x	Battery voltage too high	27	x
Bus under	03	x	Battery voltage too low	28	x
Inverter soft start fail	11	x	Over temperature	41	x
Inverter voltage high	12	x	Over load	43	
Inverter voltage Low	13	x	Charger failure	45	x













3-8. Warning indicator

Warning	Icon (flashing)	Code	Alarm
Low Battery		bL	Sounding every 2 seconds
Overload		OL	Sounding every second
Battery is not connected		NC	Sounding every 2 seconds
Over Charge		OC	Sounding every 2 seconds
Site wiring fault		SF	Sounding every 2 seconds
EPO enable		EP	Sounding every 2 seconds
Over temperature		EP	Sounding every 2 seconds
Charger failure		CH	Sounding every 2 seconds
Battery fault		bF	Sounding every 2 seconds (At this time, UPS is off to remind users something wrong with battery)
Battery replacement		bR	Sounding every 2 seconds
EEPROM error		EE	Sounding every 2 seconds

NOTE: "Site Wiring Fault" function can be enabled/disabled via software. Please check software manual for the details.

4. Troubleshooting

If the UPS system does not operate correctly, please solve the problem by using the table below.

Symptom	Possible cause	Remedy
No indication and alarm even though the mains is normal.	The AC input power is not connected well.	Check if input power cord firmly connected to the mains.
	The AC input is connected to the UPS output.	Plug AC input power cord to AC input correctly.
The icon  and the warning code  flashing on LCD display and alarm is sounding every 2 seconds.	EPO function is activated.	Set the circuit in closed position to disable EPO function.
The icon  ,  and the warning code  flashing on LCD display and alarm is sounding every 2 seconds.	Line and neutral conductors of UPS input are reversed.	Rotate mains power socket by 180° and then connect to UPS system.
The icon  ,  and the warning code  flashing on LCD display and alarm is sounding every 2 seconds.	The external or internal battery is incorrectly connected.	Check if all batteries are connected well.
Fault code is shown as 27 on LCD display and alarm is continuously sounding.	Battery voltage is too high or the charger is fault.	Contact your dealer.
Fault code is shown as 28 on LCD display and alarm is continuously sounding.	Battery voltage is too low or the charger is fault.	Contact your dealer.
The icon  ,  and the warning code  flashing on LCD display and alarm is sounding every second.	UPS is overload	Remove excess loads from UPS output.
	UPS is overloaded. Devices connected to the UPS are fed directly by the electrical network via the Bypass.	Remove excess loads from UPS output.
	After repetitive overloads, the UPS is locked in the Bypass mode. Connected devices are fed directly by the mains.	Remove excess loads from UPS output first. Then shut down the UPS and restart it.
Fault code is shown as 43 and the icon  is lighting on LCD display. Alarm is continuously sounding.	The UPS shut down automatically because of overload at the UPS output.	Remove excess loads from UPS output and restart it.

Symptom	Possible cause	Remedy
Fault code is shown as 14 on LCD display and alarm is continuously sounding.	The UPS shut down automatically because short circuit occurs on the UPS output.	Check output wiring and if connected devices are in short circuit status.
Fault code is shown as 01, 02, 03, 11, 12, 13 and 41 on LCD display and alarm is continuously sounding.	A UPS internal fault has occurred. There are two possible results: 1. The load is still supplied, but directly from AC power via bypass. 2. The load is no longer supplied by power.	Contact your dealer
Battery backup time is shorter than nominal value.	Batteries are not fully charged	Charge the batteries for at least 5 hours and then check capacity. If the problem still persists, consult your dealer.
	Batteries defect	Contact your dealer to replace the battery.
Fault code is shown as 45 on LCD display. At the same time, alarm is continuously sounding.	The charger does not have output and battery voltage is less than 10V/PC.	Contact your dealer.

5. Storage and Maintenance

Operation

The UPS system contains no user-serviceable parts. If the battery service life (3~5 years at 25°C ambient temperature) has been exceeded, the batteries must be replaced. In this case, please contact your dealer.



Be sure to deliver the spent battery to a recycling facility or ship it to your dealer in the replacement battery packing material.

Storage

Before storing, charge the UPS 5 hours. Store the UPS covered and upright in a cool, dry location. During storage, recharge the battery in accordance with the following table:

Storage Temperature	Recharge Frequency	Charging Duration
-25°C - 40°C	Every 3 months	1-2 hours
40°C - 45°C	Every 2 months	1-2 hours

6. Specifications

MODEL	1.1K	1.5K	2K	3K*
CAPACITY	1100 VA / 770 W	1500 VA / 1050 W	2000 VA / 1400 W	3000 VA / 2100 W
INPUT				
Acceptable Voltage Range	81-134 VAC/86-139 VAC/89-145AVC/102-152 VAC or 162-268 VAC/162-268 VAC/170-280AVC/177-290 VAC			
Frequency Range	60/50 Hz \pm 5 Hz (auto sensing)			
OUTPUT				
Voltage Regulation (AC Mode)	110 (-15%/+10%) /115(-14%/+10%)/120(-14%/+10%)/127(-12%/+10%) VAC or 208 (-10%/+16%) /220(-15%/+10%)/230(-15%/+10%)/240(-15%/+10%) VAC			
Voltage Regulation (Batt. Mode)	110/115/120/127 VAC or 208/220/230/240 VAC \pm 1.5%(before battery alarm)			
Frequency Range (Batt. Mode)	50 Hz or 60 Hz \pm 0.1 Hz			
Current Crest Ratio	3:1			
Harmonic Distortion	2% max @ 100% linear load, 5% max @ 100% non-linear load (before low battery alarm)			
Transfer Time	Typical 2-6 ms, 10ms max.			
Waveform (Batt. Mode)	Pure Sine Wave			
Overload capacity	AC mode	103%~120% (-5%/+10%) 5 minutes 120%~150% (-5%/+10%) 10 sec >150%(-5%/+10%) 1 sec		
	Battery mode	103%~110% (-5%/+10%) 1 minutes 110%~150% (-5%/+10%) 10 sec >150%(-5%/+10%) 0.5 sec		
EFFICIENCY				
AC Mode	96%			
Buck & Boost Mode	95%			
Battery Mode	\geq 88%, up to 90% @ nominal battery voltage			
BATTERY				
Battery Type & Number	12 V/7 Ahx2	12 V/9 Ahx2	12 V/7 Ahx4	12 V/9 Ahx4
Charging Voltage	27.4 VDC \pm 1%		54.8 VDC \pm 1%	
Recharge Time	4 hours recover to 90% capacity			
PROTECTION				
Full Protection	Overload, short, discharge, and overcharge protection			
ALARM				
Battery Mode	Sounding every 10 seconds			
Low Battery	Sounding every 2 seconds			
Overload	Sounding every second			
Battery Replacement Alarm	Sounding every 2 seconds			
Fault	Continuously sounding			
PHYSICAL				
Dimension, DXWXH (mm)	397 x 145x 220		455 x 145x 220	
Net Weight (kg)	11.65	12.35	18.1	20.3
ENVIRONMENT				
Operating Humidity	0-90 % RH @ 0- 40°C (non-condensing)			
Noise Level	Less than 45dB			
MANAGEMENT				
Smart RS-232/USB	Supports Windows® 2000/2003/XP/Vista/2008, 7/8/10, Linux, Unix, and MAC			
Optional SNMP	Power management from SNMP manager and web browser			

* Only available for 208/220/230/240VAC system.

Product specifications are subject to change without further notice.